

CMS

Common mode inductors, surface mount



Product description

- Three sizes of surface mount toroidal common mode inductors that provide 300Vdc isolation
- Inductance range from 5.5uH to 1600uH
- Current range up to 7.0 Amps
- Noise attenuation up to 44 dB
- Frequency range up to 100 MHz
- Meets UL94V-0 flammability standard
- Ferrite core material



Applications

- EMI filters
- DC-DC brick power supplies
- Discrete output supplies
- Discrete and point-of-use power supplies (PUPS)

Environmental data

- Storage temperature range: -40°C to +160°C
- Operating ambient temperature range: -40°C to +160°C (range is application specific)
- Solder reflow temperature: J-STD-020D compliant

Product specifications

| Part number | OCL (uH) minimum (1-2) & (4-3) | I rms. Amperes Max* | DCR (Ω) typ @ 20°C (1-2) | DCR (Ω) typ @ 20°C (4-3) | Leakage Inductance (uH) typ | Interwinding Capacitance (pF) typ |
|-------------|--------------------------------|---------------------|--------------------------|--------------------------|-----------------------------|-----------------------------------|
| CMS1-1-R | 4.5 | 7.00 | 0.0027 | 0.0027 | 0.05 | 2.0 |
| CMS1-2-R | 8 | 5.70 | 0.0040 | 0.0040 | 0.09 | 2.1 |
| CMS1-3-R | 12.6 | 4.10 | 0.077 | 0.077 | 0.14 | 2.2 |
| CMS1-4-R | 18 | 3.80 | 0.0089 | 0.0089 | 0.20 | 2.3 |
| CMS1-5-R | 25 | 3.60 | 0.0100 | 0.0100 | 0.28 | 2.4 |
| CMS1-6-R | 32.8 | 3.10 | 0.0138 | 0.0138 | 0.36 | 2.5 |
| CMS1-7-R | 41.5 | 2.60 | 0.019 | 0.019 | 0.45 | 2.6 |
| CMS1-8-R | 51.2 | 2.20 | 0.026 | 0.026 | 0.056 | 2.7 |
| CMS1-9-R | 62 | 1.90 | 0.035 | 0.035 | 0.68 | 2.7 |
| CMS1-10-R | 73.7 | 1.65 | 0.048 | 0.048 | 0.81 | 2.8 |
| CMS1-11-R | 100 | 1.35 | 0.070 | 0.070 | 1.10 | 2.8 |
| CMS1-12-R | 131 | 1.15 | 0.100 | 0.100 | 1.45 | 2.9 |
| CMS1-13-R | 166 | 1.00 | 0.138 | 0.138 | 1.83 | 3.0 |
| CMS1-14-R | 205 | 0.85 | 0.186 | 0.186 | 2.25 | 3.1 |
| CMS2-0-R | 14 | 6.00 | 0.004 | 0.004 | 0.13 | 1.7 |
| CMS2-1-R | 25 | 5.35 | 0.005 | 0.005 | 0.22 | 3.2 |
| CMS2-2-R | 40 | 4.40 | 0.008 | 0.008 | 0.34 | 2.0 |
| CMS2-3-R | 57 | 3.60 | 0.012 | 0.012 | 0.47 | 2.3 |
| CMS2-4-R | 102 | 2.80 | 0.019 | 0.019 | 0.80 | 2.5 |
| CMS2-5-R | 160 | 2.30 | 0.029 | 0.029 | 1.25 | 2.8 |
| CMS2-6-R | 230 | 1.85 | 0.044 | 0.044 | 1.75 | 3.1 |
| CMS2-7-R | 270 | 1.60 | 0.060 | 0.060 | 2.00 | 3.4 |
| CMS2-8-R | 360 | 1.35 | 0.084 | 0.084 | 2.60 | 3.6 |
| CMS2-9-R | 460 | 1.10 | 0.120 | 0.120 | 3.30 | 3.9 |
| CMS2-10-R | 575 | 0.94 | 0.170 | 0.170 | 4.00 | 4.1 |
| CMS2-11-R | 700 | 0.80 | 0.230 | 0.230 | 5.00 | 4.3 |
| CMS2-12-R | 915 | 0.67 | 0.330 | 0.330 | 6.30 | 4.6 |
| CMS2-13-R | 1070 | 0.58 | 0.440 | 0.440 | 7.30 | 4.9 |
| CMS2-14-R | 1340 | 0.50 | 0.620 | 0.620 | 9.00 | 5.1 |
| CMS3-1-R | 28 | 5.70 | 0.005 | 0.005 | 0.31 | 5.4 |
| CMS3-2-R | 45 | 5.10 | 0.006 | 0.006 | 0.46 | 2.80 |
| CMS3-3-R | 64 | 4.75 | 0.007 | 0.007 | 0.64 | 3.05 |
| CMS3-4-R | 88 | 3.95 | 0.010 | 0.010 | 0.85 | 3.50 |
| CMS3-5-R | 146 | 3.10 | 0.017 | 0.017 | 1.30 | 3.70 |
| CMS3-6-R | 217 | 2.85 | 0.020 | 0.020 | 1.90 | 3.90 |
| CMS3-7-R | 258 | 2.45 | 0.027 | 0.027 | 2.20 | 4.15 |
| CMS3-8-R | 350 | 2.00 | 0.040 | 0.040 | 3.00 | 4.40 |
| CMS3-9-R | 400 | 1.70 | 0.053 | 0.053 | 3.30 | 4.65 |
| CMS3-10-R | 518 | 1.45 | 0.076 | 0.076 | 4.20 | 4.85 |
| CMS3-11-R | 648 | 1.20 | 0.107 | 0.107 | 5.10 | 5.10 |
| CMS3-12-R | 790 | 1.05 | 0.145 | 0.145 | 6.10 | 5.35 |
| CMS3-13-R | 1030 | 0.88 | 0.210 | 0.210 | 7.80 | 5.55 |
| CMS3-14-R | 1310 | 0.75 | 0.300 | 0.300 | 9.60 | 5.80 |

Definitions:

OCL = Open Circuit Inductance
DCR = Direct Current Resistance
I_{rms} = rms current for approx. a 40°C temperature rise at an ambient temperature of 85°C.
*Operating Temperature: 160°C Max. Inductance values are sustained up to 160°C.

Electrical Characteristics:

OCL (1-2) 0.10V_{rms}, 100kHz, 0.0Adc: (See Chart)
OCL (4-3) 0.10V_{rms}, 100kHz, 0.0Adc: (See Chart)
DCR (1-2) typ @ 20°C: (See Chart)
DCR (4-3) typ @ 20°C: (See Chart)
Hipot rating: winding to winding: 300Vdc min. for 1 second.
Turns Ratio: (1-2):(4-3) 1:1

Dimensions—mm

CMS1

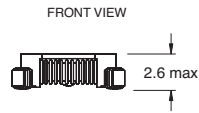
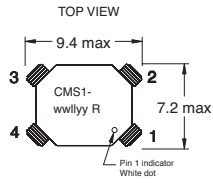

RECOMMENDED PCB LAYOUT

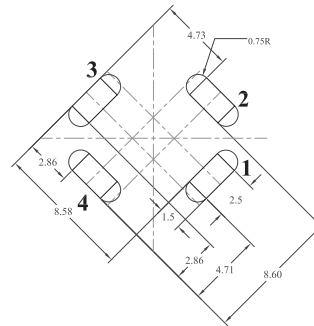

SCHEMATIC

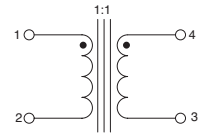

CMS2

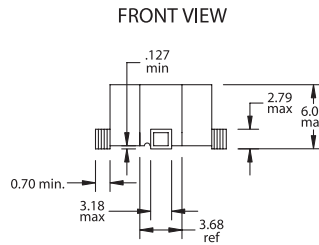
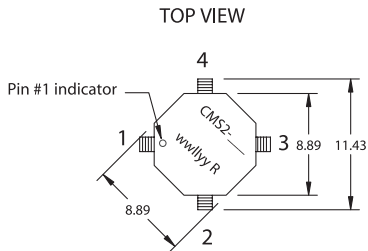

RECOMMENDED PCB LAYOUT

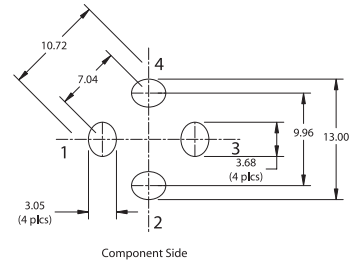

SCHEMATIC

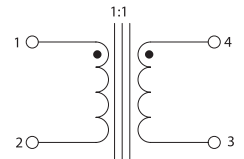

CMS3

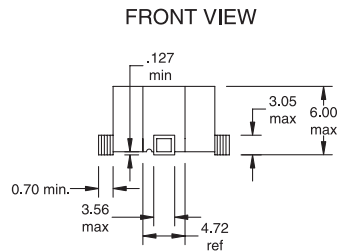
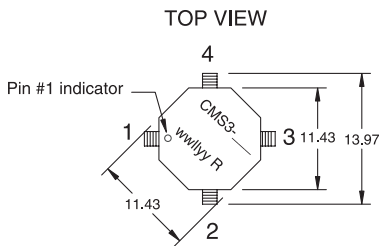

RECOMMENDED PCB LAYOUT

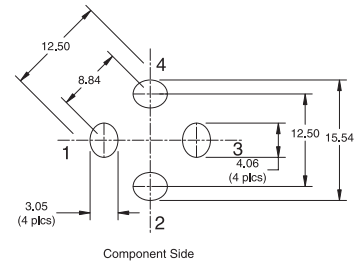

SCHEMATIC

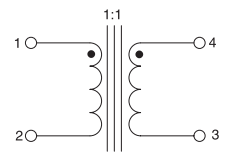

willyy = Date code R = Revision level

Packaging Information

CMS1

Supplied in tape and reel packaging, 2,000 parts per 13" diameter reel

CMS2

Supplied in tape and reel packaging, 800 parts per 13" diameter reel

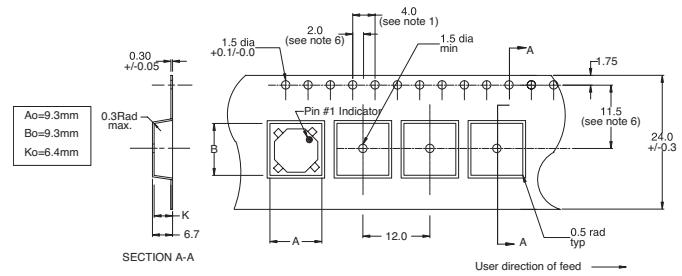
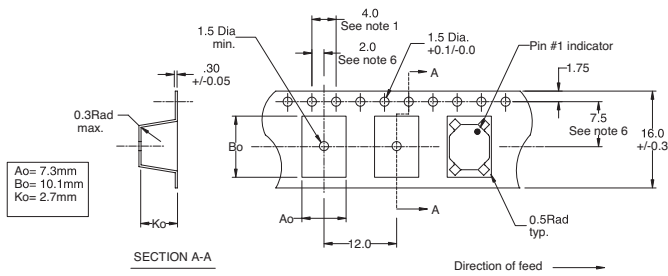

CMS3

Supplied in tape and reel packaging, 600 parts per 13" diameter reel

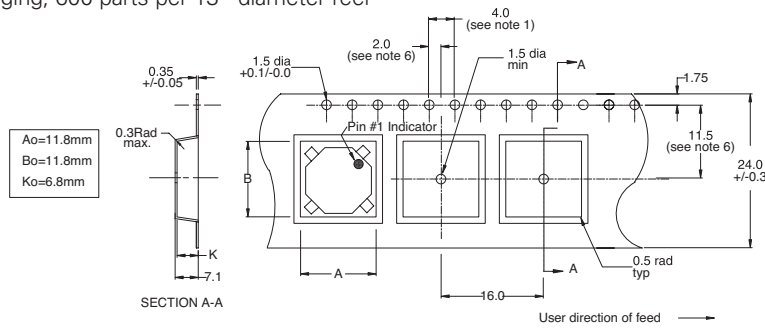

Attenuation Curves

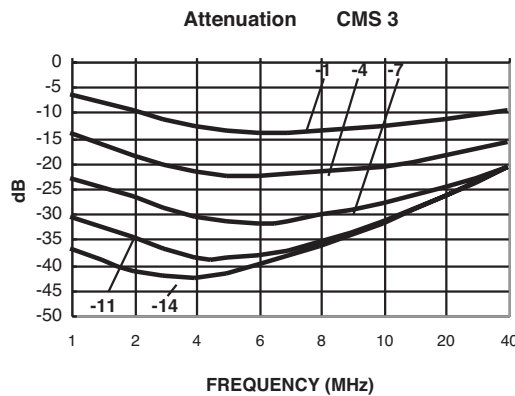
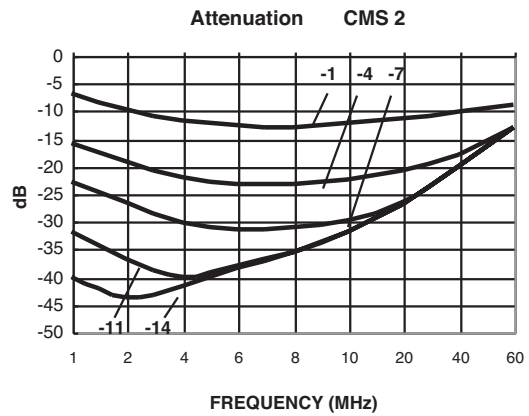
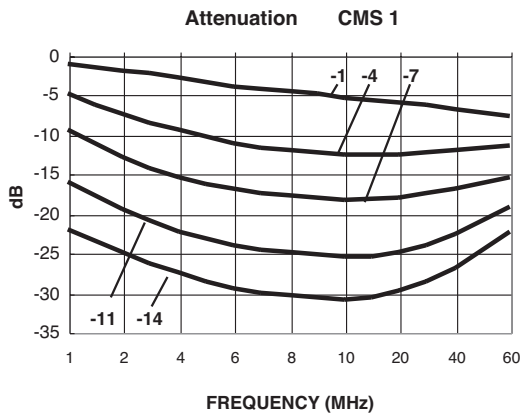

Impedance Curves

Impedance CMS1-1 & 4

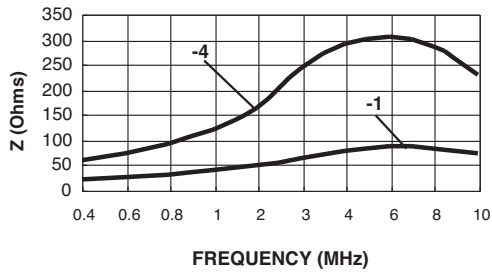

Impedance CMS1 - 7,11, & 14

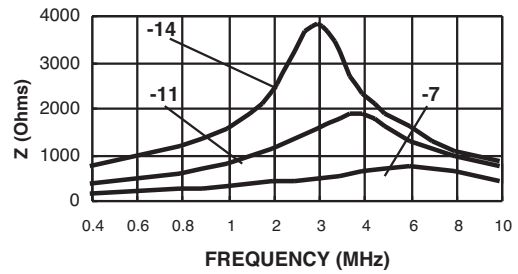

Impedance CMS2 - 1 & 4

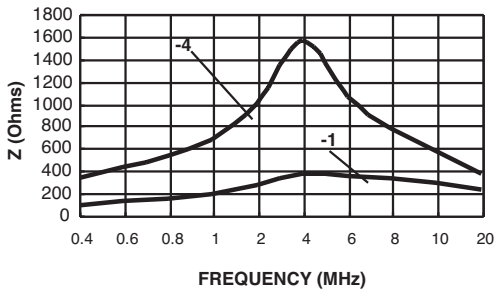

Impedance CMS2 - 7,11, & 14

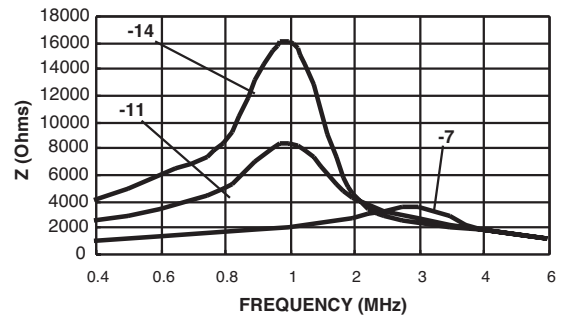

Impedance CMS3 - 1 & 4

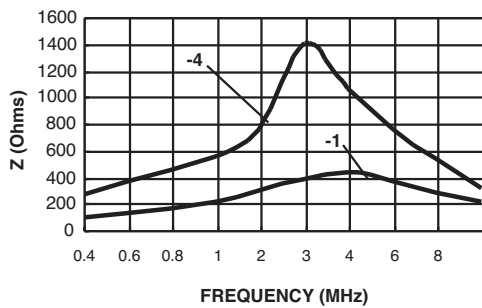

Impedance CMS3 - 7,11, & 14

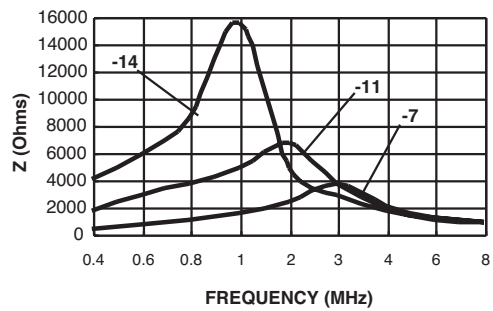

Solder reflow profile

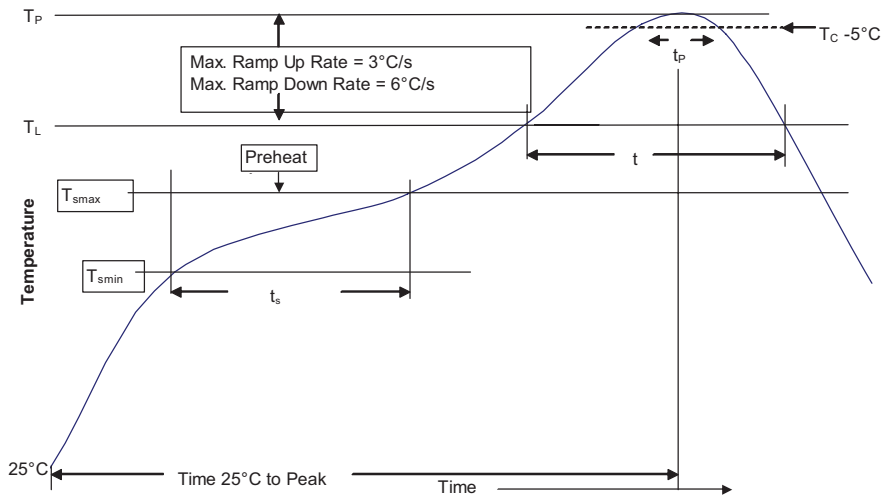

Table 1 - Standard SnPb Solder (T_c)

| Package Thickness | Volume mm ³ <350 | Volume mm ³ ≥350 |
|-------------------|-----------------------------|-----------------------------|
| <2.5mm) | 235°C | 220°C |
| ≥2.5mm | 220°C | 220°C |

Table 2 - Lead (Pb) Free Solder (T_c)

| Package Thickness | Volume mm ³ <350 | Volume mm ³ 350 - 2000 | Volume mm ³ >2000 |
|-------------------|-----------------------------|-----------------------------------|------------------------------|
| <1.6mm | 260°C | 260°C | 260°C |
| 1.6 - 2.5mm | 260°C | 250°C | 245°C |
| >2.5mm | 250°C | 245°C | 245°C |

Reference JDEC J-STD-020D

| Profile Feature | Standard SnPb Solder | Lead (Pb) Free Solder |
|--|----------------------|-----------------------|
| Preheat and Soak | | |
| • Temperature min. (T _{smin}) | 100°C | 150°C |
| • Temperature max. (T _{smax}) | 150°C | 200°C |
| • Time (T _{smin} to T _{smax}) (t _s) | 60-120 Seconds | 60-120 Seconds |
| Average ramp up rate T _{smax} to T _p | 3°C/ Second Max. | 3°C/ Second Max. |
| Liquidous temperature (T _L) | 183°C | 217°C |
| Time at liquidous (t _L) | 60-150 Seconds | 60-150 Seconds |
| Peak package body temperature (T _p)* | Table 1 | Table 2 |
| Time (t _p)** within 5 °C of the specified classification temperature (T _c) | 20 Seconds** | 30 Seconds** |
| Average ramp-down rate (T _p to T _{smax}) | 6°C/ Second Max. | 6°C/ Second Max. |
| Time 25°C to Peak Temperature | 6 Minutes Max. | 8 Minutes Max. |

* Tolerance for peak profile temperature (T_p) is defined as a supplier minimum and a user maximum.

** Tolerance for time at peak profile temperature (t_p) is defined as a supplier minimum and a user maximum.

Life Support Policy: Eaton does not authorize the use of any of its products for use in life support devices or systems without the express written approval of an officer of the Company. Life support systems are devices which support or sustain life, and whose failure to perform, when properly used in accordance with instructions for use provided in the labeling, can be reasonably expected to result in significant injury to the user.

Eaton reserves the right, without notice, to change design or construction of any products and to discontinue or limit distribution of any products. Eaton also reserves the right to change or update, without notice, any technical information contained in this bulletin.

Eaton
Electronics Division
1000 Eaton Boulevard
Cleveland, OH 44122
United States
www.eaton.com/elx

Ihr Vertriebspartner:
HY-LINE[®]
POWER COMPONENTS

Inselkammerstraße 10
D-82008 Unterhaching
Tel.: +49 (0)89 614503 10
Fax: +49 (0)89 614503 20
E-Mail: power@hy-line.de
URL: www.hy-line.de

Hochstrasse 355
CH-8200 Schaffhausen
Tel.: +41 (0)52 647 42 00
Fax: +41 (0)52 647 42 01
E-Mail: power@hy-line.ch
URL: www.hy-line.ch