

# Low-Noise Synchronous PWM/PFM Step-Down DC/DC Converter

## FEATURES

- 2.5V to 5.5V Input Voltage Range
- 600mA Guaranteed Output Current
- 95% Efficiency
- No Schottky Diode Required
- 30 $\mu$ A Low Quiescent Current
- 100% Duty Cycle in Low Dropout Operation
- 1.5MHz Fixed-Frequency PWM Operation
- Accurate Reference 0.6V Provides Low Output Voltages
- Small 5-Pin SOT23 Package
- Internal Soft-Start Function(100 $\mu$ s)

## APPLICATIONS

- Cellular Phones
- CPU I/O Supplies
- Cordless Phones
- Notebook Chipset Supplies
- PDAs and Handy-Terminals
- Battery-Operated Devices (1 Li-Ion or 3 NiMH/ NiCd).

## DESCRIPTION

The AIC2351 is a low-noise, pulse-width-modulated (PWM), DC-DC step-down converter. The device is available in an adjustable version and fixed output voltages of 1.2V, 1.5V, 1.8V, 2.5V, and 3.3V. AIC2351 is capable of delivering continuous 600mA output current over a wide input voltage range from 2.5V to 5.5V. However, it can provide higher peak current. For example, over 1A peak current in the condition of 5V input and 1.2V output. See Fig.13 for detail.

The device features an internal synchronous rectifier for high efficiency; it requires no external Schottky diode. Internally fixed-frequency 1.5MHz operation provides easy post-filtering and allows the use of small inductors and capacitors. The AIC2351 is ideally suited for Li-Ion battery applications. PWM/PFM mode extends battery life by switching to a pulse-frequency-modulated mode during light loads. Shutdown mode places the device in standby, reducing quiescent supply current to under 0.1 $\mu$ A.

Other features of the AIC2351 include high efficiency, low dropout voltage, and an accurate reference 0.6V provides low output voltages. It is available in a space-saving 5-pin SOT23 package.

## APPLICATIONS CIRCUIT

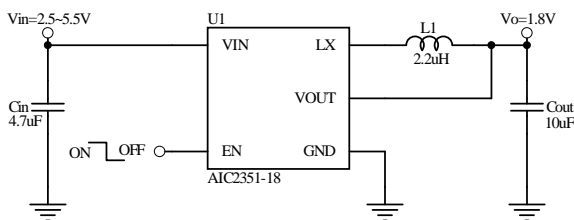

Fig. 1 Fixed Step-Down DC/DC Converter

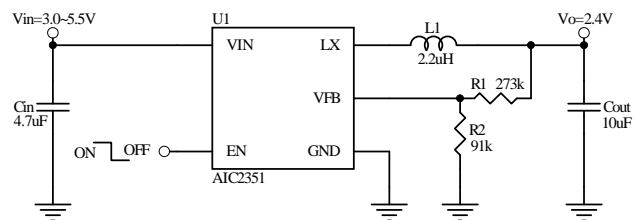
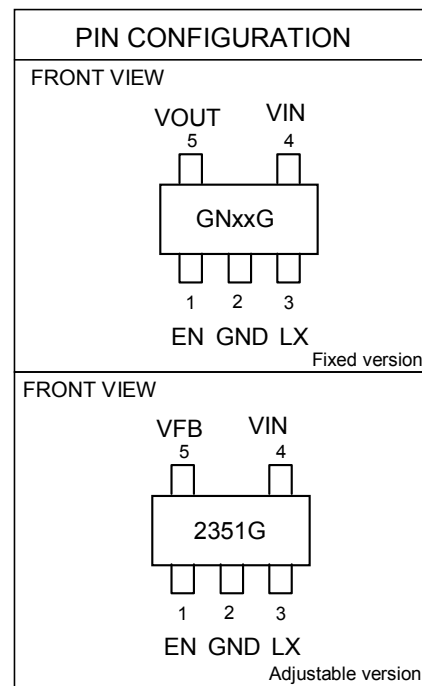
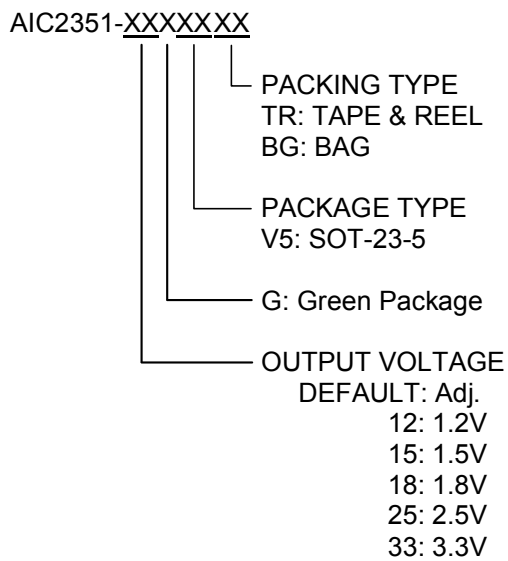

Fig. 2 Adjustable Step-Down DC/DC Converter

**ORDERING INFORMATION**

- Example: AIC2351-33GV5TR  
 → 3.3V Output Version, in SOT-23-5 Green Package & Tape & Reel Packing Type
- AIC2351GV5TR  
 → Adjustable Version, in SOT-23-5 Green Package & Tape & Reel Packing Type

**● Marking (Fixed Version)**

Part No.	Marking
AIC2351-12GV5	GN12G
AIC2351-15GV5	GN15G
AIC2351-18GV5	GN18G
AIC2351-25GV5	GN25G
AIC2351-33GV5	GN33G

**● Marking (Adjustable Version)**

Part No.	Marking
AIC2351GV5	2351G

**■ ABSOLUTE MAXIMUM RATINGS**

VIN, LX to GND .....	-0.3 V to 6.0V
VFB, VOUT, EN to GND .....	-0.3 V to VIN
Operating Ambient Temperature Range TA.....	-40°C to 85°C
Operating Maximum Junction Temperature TJ.....	150°C
Storage Temperature Range TSTG.....	-65°C to 150°C
Lead Temperature (Soldering 10 Sec.).....	260°C
Thermal Resistance Junction to Case     SOT-23-5.....	115°C/W
Thermal Resistance Junction to Ambient   SOT-23-5.....	250°C/W

(Assume no Ambient Airflow, no Heatsink)

**Absolute Maximum Ratings are those values beyond which the life of a device may be impaired.**

**■ ELECTRICAL CHARACTERISTICS**

( $T_A=25^\circ\text{C}$ ,  $V_{IN}=3.6\text{V}$ , unless otherwise specified.) (Note 1)

PARAMETER	CONDITIONS	SYMBOL	MIN	TYP	MAX	UNITS
Input Voltage Range		$V_{IN}$	2.5		5.5	V
Output Adjustment Range		$V_{OUT}$	$V_{FB}$		$V_{IN} - 0.2$	V
Feedback Voltage	$V_{FB} = V_{OUT}$ , $V_{IN} = 3.6\text{V}$ , $I_{OUT} = 0\text{A}$ $T_A=25^\circ\text{C}$	$V_{FB}$	0.588	0.6	0.612	V
Fixed Output Voltage	AIC2351-12, $I_{OUT} = 0.1\text{A}$	$V_{OUT}$	-2		+2	%
	AIC2351-15, $I_{OUT} = 0.1\text{A}$		-2		+2	%
	AIC2351-18, $I_{OUT} = 0.1\text{A}$		-2		+2	%
	AIC2351-25, $I_{OUT} = 0.1\text{A}$		-2		+2	%
	AIC2351-33, $I_{OUT} = 0.1\text{A}$		-2		+2	%
Line Regulation	Duty cycle = 100% to 23%			1		%
Load Regulation	$I_{OUT} = 0$ to 600mA			1.3		%
FB Input Current	$V_{FB} = 1.4\text{V}$	$I_{FB}$		0.01		nA
P-Channel On-Resistance	$I_{LX} = 100\text{mA}$ , $V_{IN}=3.6\text{V}$	$P_{RDS(ON)}$		0.4	0.65	$\Omega$
N-Channel On-Resistance	$I_{LX} = -100\text{mA}$ , $V_{IN}=3.6\text{V}$	$N_{RDS(ON)}$		0.35	0.8	$\Omega$
Peak Inductor Current		$I_{PK}$		1.4		A
Quiescent Current	$V_{FB}=0.66\text{V}$ , $I_{OUT}=0\text{A}$			30	50	$\mu\text{A}$
	$V_{FB}=0.50\text{V}$ , $I_{OUT}=0\text{A}$		100	150	220	$\mu\text{A}$
Shutdown Supply Current				0.1	1	$\mu\text{A}$
Oscillator Frequency		$f_{OSC}$	1.2	1.5	1.8	MHz
Maximum Duty Cycle		$D_{MAX}$	100			%
EN Pin Current	$V_{EN} = V_{IN}$	$I_{EN}$		0.1	1	$\mu\text{A}$
EN Input Threshold	Output ON	$V_{ENH}$	1.6			V
	Output OFF	$V_{ENL}$			0.25	V

Note 1: Specifications are production tested at  $T_A=25^\circ\text{C}$ . Specifications over the  $-40^\circ\text{C}$  to  $85^\circ\text{C}$  operating temperature range are assured by design, characterization and correlation with Statistical Quality Controls (SQC).

**TYPICAL PERFORMANCE CHARACTERISTICS**

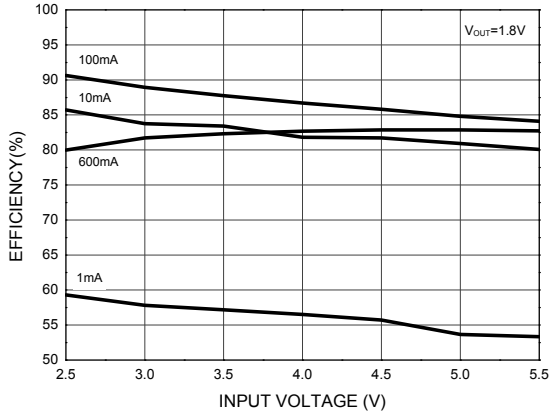

Fig. 3 Efficiency vs. Input Voltage

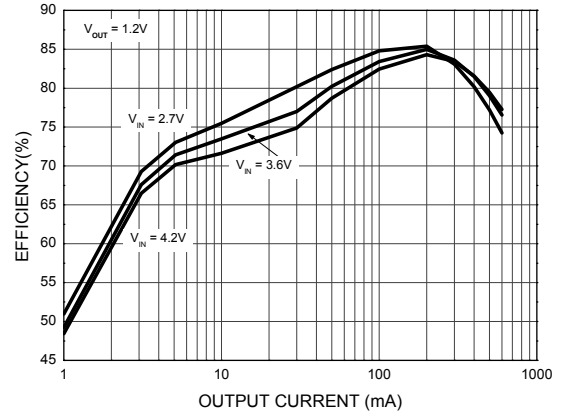

Fig. 4 Efficiency vs. Output Current

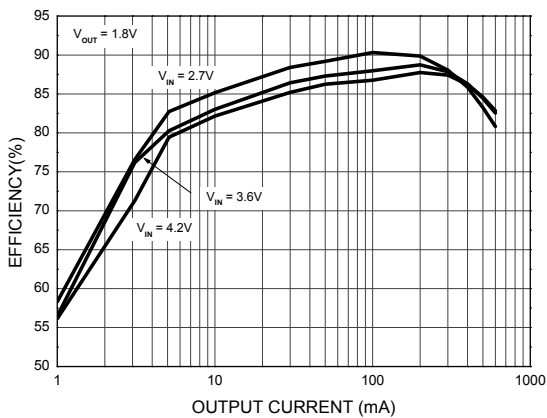

Fig. 5 Efficiency vs. Output Current

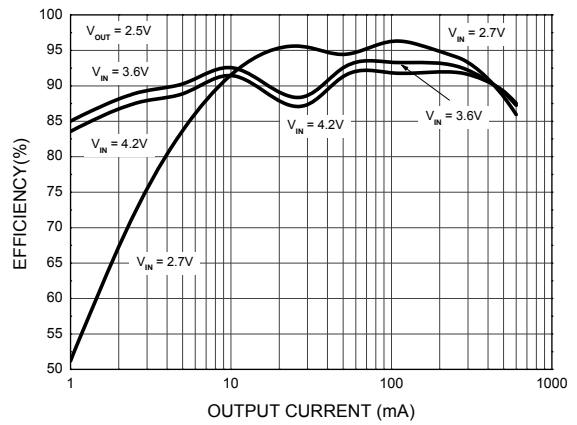

Fig. 6 Efficiency vs. Output Current

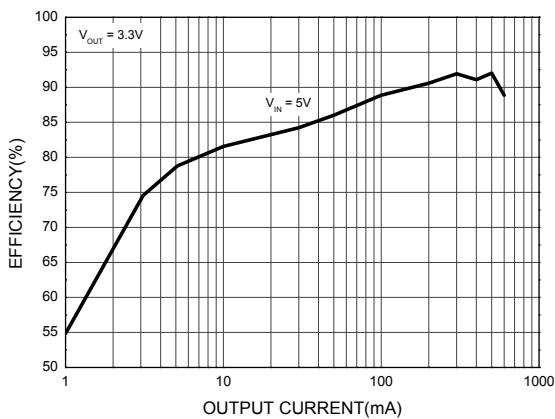
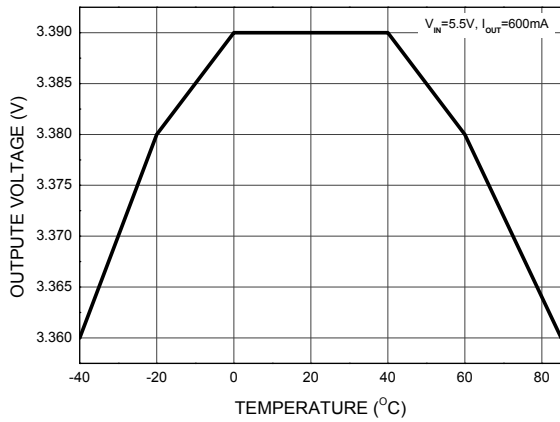
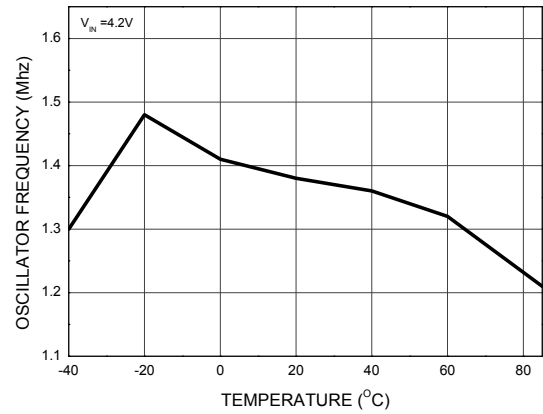
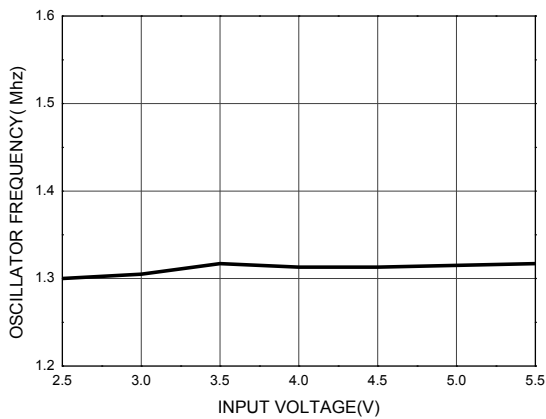
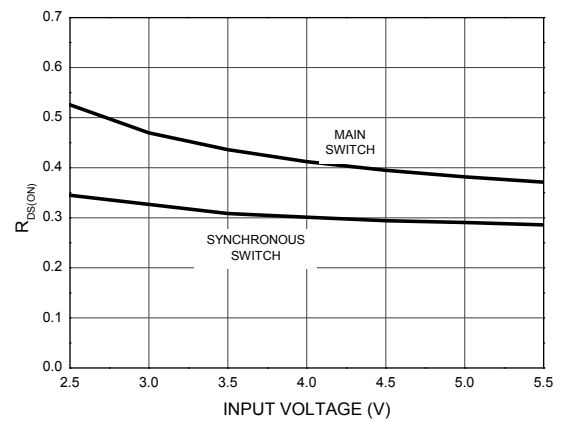
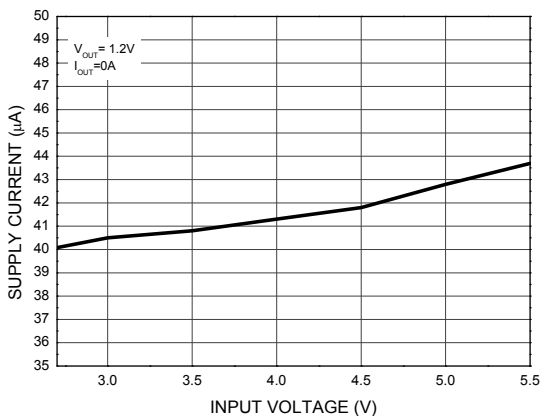
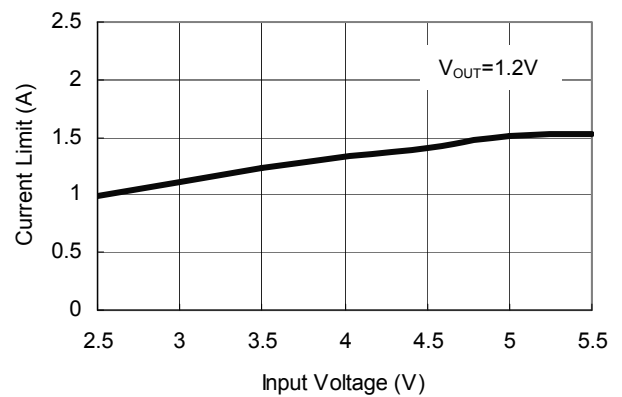
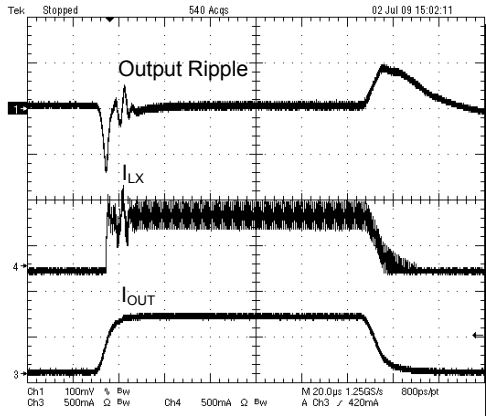
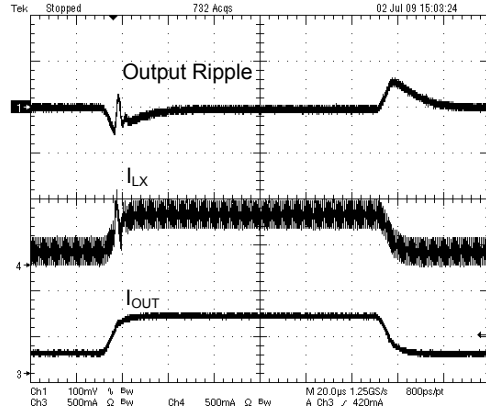
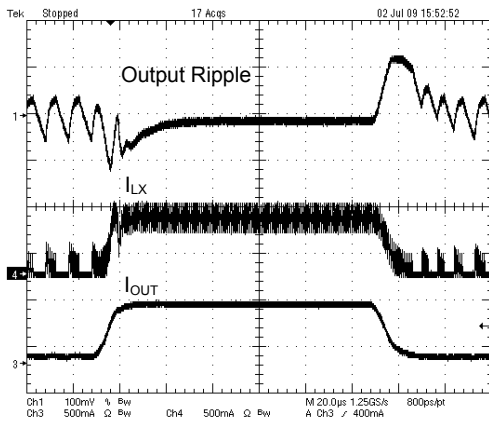
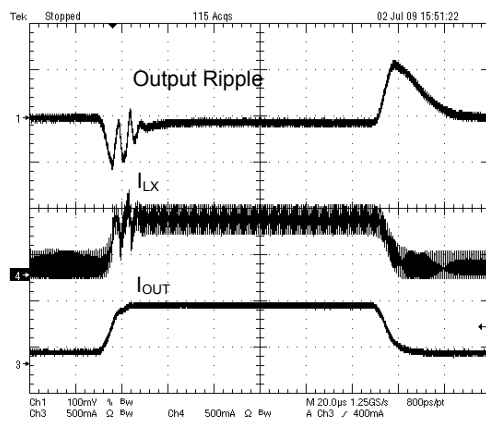
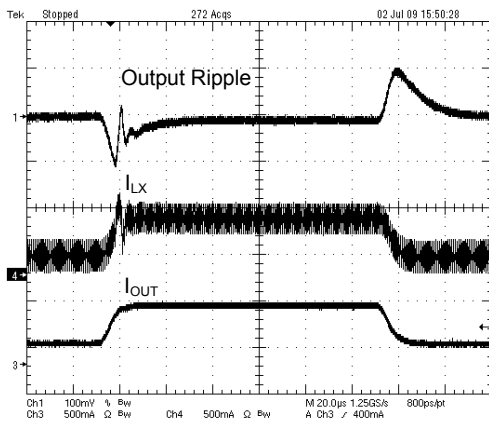
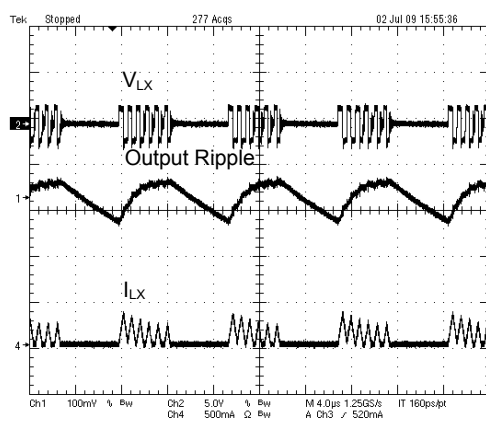
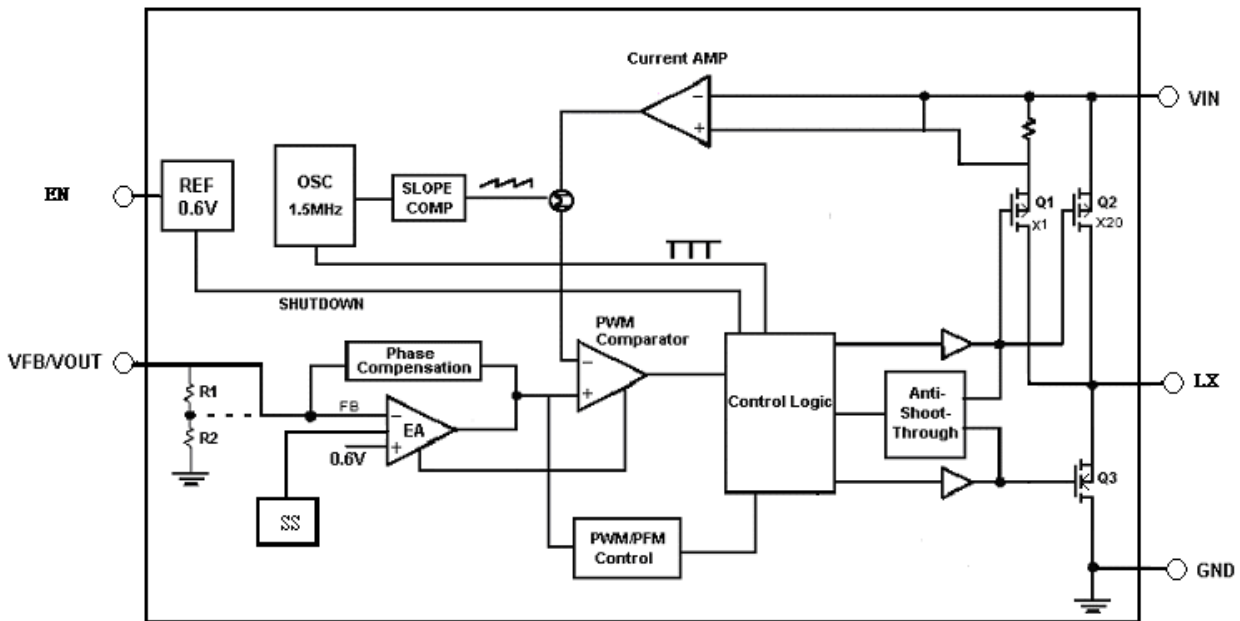

Fig. 7 Efficiency vs. Output Current

**■ TYPICAL PERFORMANCE CHARACTERISTICS (Continuous)**

**Fig. 8 Output Voltage vs. Temperature**

**Fig. 9 Oscillator Frequency vs. Temperature**

**Fig. 10 Oscillator Frequency vs. Input Voltage**

**Fig. 11 R<sub>DS(ON)</sub> vs. Input Voltage**

**Fig. 12 Supply Current vs. Input Voltage**

**Fig. 13 Current Limit vs. Input Voltage**

**TYPICAL PERFORMANCE CHARACTERISTICS (Continuous)**

 $V_{IN}=3.6V; V_{OUT}=1.2V; L=2.2\mu F; C_{OUT}=10\mu F; I_{OUT}=0mA \text{ to } 600mA$ 
**Fig. 14 Load Transient Response**

 $V_{IN}=3.6V; V_{OUT}=1.2V; L=2.2\mu F; C_{OUT}=10\mu F; I_{OUT}=200mA \text{ to } 600mA$ 
**Fig. 15 Load Transient Response**

 $V_{IN}=3.6V; V_{OUT}=1.8V; L=2.2\mu F; C_{OUT}=10\mu F; I_{OUT}=50mA \text{ to } 600mA$ 
**Fig. 16 Load Transient Response**

 $V_{IN}=3.6V; V_{OUT}=1.8V; L=2.2\mu F; C_{OUT}=10\mu F; I_{OUT}=100mA \text{ to } 600mA$ 
**Fig. 17 Load Transient Response**

 $V_{IN}=3.6V; V_{OUT}=1.8V; L=2.2\mu F; C_{OUT}=10\mu F; I_{OUT}=200mA \text{ to } 600mA$ 
**Fig. 18 Load Transient Response**

 $V_{IN}=3.6V; V_{OUT}=1.8V; L=2.2\mu F; C_{OUT}=10\mu F; I_{OUT}=50mA$ 
**Fig. 19 PFM Operation**

**■ BLOCK DIAGRAM**

**■ PIN DESCRIPTIONS**

PIN 1: EN - ON/OFF Control Pin. The Device will turn off when EN is Low. This pin isn't allowed to float.

PIN 2: GND - Ground.

PIN 3: LX - LX Pin. The LX node connects to the inductor.

PIN 4: VIN - Main Power Supply Pin.

PIN 5: VOUT - Output Voltage Feedback Pin. (For fixed version)

PIN 5: VFB - Feedback Pin. (For adjustable version)



## ■ APPLICATION INFORMATION

### Operation

The AIC2351 is a low-noise and fixed-frequency step-down DC/DC converter with current-mode PWM control architecture. It features an internal synchronous rectifier, which eliminates the external Schottky diode and increases efficiency. During normal operation, the AIC2351 can regulate its output voltage through a feedback control circuit, which is composed of an error amplifier; a current comparator and several control signal generators. By comparing the feedback voltage to the reference voltage of 0.6V, the error amplifier varies its output voltage. The output voltage of the error amplifier is compared with the summing signal of current sensing signal and slope compensation signal to determine the duty cycle of internal main power switch (P-channel MOSFET). While the main power switch is turned on, the synchronous power switch (N-channel MOSFET) will be turned off through anti-short-through block. Similarly, when the main power switch is turned off, the synchronous power switch will be turned on until the inductor current starts to reverse or the beginning of the next switching cycle. In order to achieve better efficiency and prevent overcharging the output capacitor, AIC2351 will enter pulse-frequency-modulated mode (PFM) operation while working at light load conditions.

### Current Limitation

The AIC2351 provides current limit function by using an internal sensing resistor. When the main power switch turns on, current follows through the internal sensing resistor. And current amplifier senses the voltage, which crosses the resistor, and amplifies it. While the sensed voltage gets higher than reference voltage, the current limitation function is activated. While the current limitation function is activated, the duty cycle will be reduced to limit the output power to protect the internal power switches.

### Short Circuit Protection

While the output is shorted to ground, the switching

frequency of AIC2351 will be reduced to third of the normal switching frequency. This lower switching frequency ensures the inductor current has more time to discharge, thereby preventing inductor current runaway. The switching frequency will automatically return to its designed value while short circuit condition is released.

### Shutdown

By connecting the EN pin to GND, the AIC2351 can be shut down to reduce the supply current to 0.1 $\mu$ A (typical). At this operation mode, the output voltage of step-down converter is equal to 0V.

### 100% Duty Cycle Operation

When the input voltage approaches the output voltage, the AIC2351 smoothly transits to 100% duty cycle operation. This allows AIC2351 to regulate the output voltage until AIC2351 completely enters 100% duty cycle operation. In 100% duty cycle mode, the output voltage is equal to the input voltage minus the voltage, which is the drop across the main power switch.

The AIC2351 achieves 100% duty cycle operation by extending the turn-on time of the main power switch. If the summing signal of current sensing signal and slope compensation signal does not reach the output voltage level of the error amplifier at the end of 90% switching period, the main power switch is continuously turned on and the oscillator remains off until the summing signal of current sensing signal and slope compensation signal reaches the output voltage level of the error amplifier. After the summing signal of current sensing signal and slope compensation signal reaches the output voltage level of the error amplifier, the main power switch is turned off and the synchronous power switch is turned on for a constant off time. At the end of the constant off time, the next switching cycle is begun. While the input voltage approaches the output voltage, the switching frequency decreases gradually to smoothly transit to 100% duty cycle operation.

If input voltage is very close to output voltage, the switching mode goes from pure PWM mode to 100% duty cycle operation. During this transient state mentioned above, large output ripple voltage may appear on output terminal.

## Components Selection

### Inductor

The inductor selection depends on the current ripple of inductor, the input voltage and the output voltage.

$$L \geq \frac{V_{OUT}}{f_{OSC} \cdot \Delta I_L} \left( 1 - \frac{V_{OUT}}{V_{IN}} \right)$$

Accepting a large current ripple of inductor allows the use of a smaller inductance. However, higher current ripple of inductor can cause higher output ripple voltage and large core loss. By setting an acceptable current ripple of inductor, a suitable inductance can be obtained from above equation.

In addition, it is important to ensure the inductor saturation current exceeds the peak value of inductor current in application to prevent core saturation. The peak value of inductor current can be calculated according to the following equation.

$$I_{PEAK} = I_{OUT(max)} + \frac{V_{OUT}}{2 \times f_{OSC} \cdot L} \left( 1 - \frac{V_{OUT}}{V_{IN}} \right)$$

### Input Capacitor and Output Capacitor

To prevent the high input voltage ripple and noise resulted from high frequency switching, the use of low ESR ceramic capacitor for the maximum RMS current is recommended. The approximated RMS current of the input capacitor can be calculated according to the following equation.

$$I_{CINRMS} \approx \sqrt{I_{OUT(MAX)}^2 \times \frac{V_{OUT}(V_{IN} - V_{OUT})}{V_{IN}^2} + \frac{\Delta I_L^2}{12}}$$

The selection of output capacitor depends on the required output voltage ripple. The output voltage ripple can be expressed as:

$$\Delta V_{OUT} = \frac{\Delta I_L}{8 \times f_{OSC} \cdot C_{OUT}} + ESR \cdot \Delta I_L$$

For lower output voltage ripple, the use of low ESR ceramic capacitor is recommended. The tantalum capacitor can also be used well, but its ESR is larger than that of ceramic capacitor.

When choosing the input and output ceramic capacitors, X5R and X7R types are recommended because they retain their capacitance over wider ranges of voltage and temperature than other types.

When using the ceramic capacitor as the input capacitor, the high input voltage transient may be generated at some start-up conditions, such as connecting the input to a live power source. By adding a small resistor in series with the input ceramic capacitor, the high input voltage transient can be improved.

### Output Voltage Programming (AIC2351 Adjustable Version Only)

By connecting a resistive divider  $R_1$  and  $R_2$ , the output voltage of AIC2351 step-down converter can be set.  $V_{OUT}$  can be calculated as:

$$V_{OUT} = 0.6 \times \left( 1 + \frac{R_1}{R_2} \right)$$

The resistive divider should sit as close to VFB pin as possible.

### Layout Consideration

In order to ensure a proper operation of AIC2351, the following points should be managed comprehensively.

1. The input capacitor and  $V_{IN}$  should be placed as close as possible to each other to reduce the input voltage ripple and noise.
2. The output loop, which is consisted of the inductor, the internal main power switch, the internal synchronous power switch and the output capacitor, should be kept as small as possible.
3. The routes with large current should be kept short and wide.
4. Logically the large current on the converter should flow at the same direction.
5. The VFB pin should be connected to the feedback resistors directly and the route should be away from the noise sources.

**PHYSICAL DIMENSIONS**

- SOT-23-5 (unit: mm)

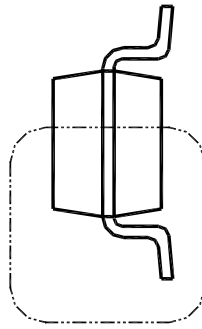
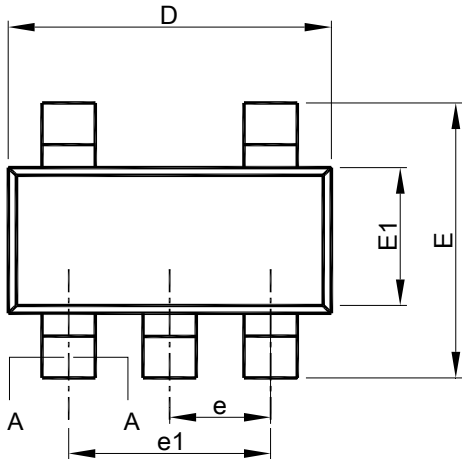

SEE VIEW B

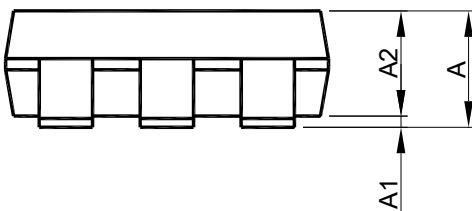

WITH PLATING

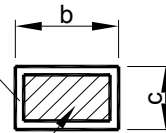

BASE METAL

SECTION A-A

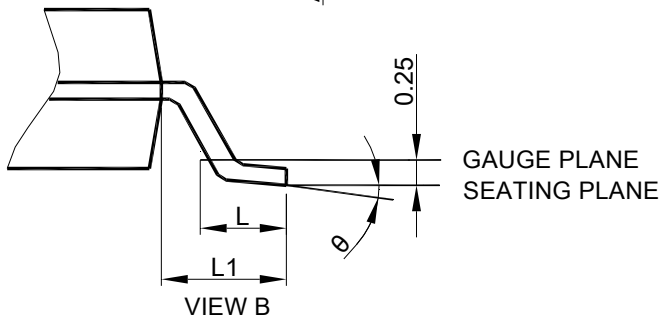

VIEW B

Note : 1. Refer to JEDEC MO-178AA.

2. Dimension "D" does not include mold flash, protrusions or gate burrs. Mold flash, protrusion or gate burrs shall not exceed 10 mil per side.
3. Dimension "E1" does not include inter-lead flash or protrusions.
4. Controlling dimension is millimeter, converted inch dimensions are not necessarily exact.

SYMBOL	SOT-23-5	
	MILLIMETERS	
	MIN.	MAX.
A	0.95	1.45
A1	0.00	0.15
A2	0.90	1.30
b	0.30	0.50
c	0.08	0.22
D	2.80	3.00
E	2.60	3.00
E1	1.50	1.70
e	0.95 BSC	
e1	1.90 BSC	
L	0.30	0.60
L1	0.60 REF	
θ	0°	8°

**Note:**

Information provided by AIC is believed to be accurate and reliable. However, we cannot assume responsibility for use of any circuitry other than circuitry entirely embodied in an AIC product; nor for any infringement of patents or other rights of third parties that may result from its use. We reserve the right to change the circuitry and specifications without notice.

Life Support Policy: AIC does not authorize any AIC product for use in life support devices and/or systems. Life support devices or systems are devices or systems which, (i) are intended for surgical implant into the body or (ii) support or sustain life, and whose failure to perform, when properly used in accordance with instructions for use provided in the labeling, can be reasonably expected to result in a significant injury to the user.