

Cadex C7000 Series

Battery Analyzer

User's Manual

Cadex C7200, C7400 & C7400ER

Cadex Electronics Inc.

**22000 Fraserwood Way
Richmond, British Columbia
Canada V6W 1J6**

Tel: +1 604 231-7777

Web: www.cadex.com

Fax +1 604 231-7755

E-mail: info@cadex.com

Manual P/N: 89-307-1013 Rev 11

November 2005

Printed in Canada

Firmware Version 6.11

Safety Notice

Trademark

Cadex, BatteryShop, QuickLearn and QuickTest are registered trademarks of Cadex Electronics Inc. All other trademarks mentioned herein are the property of their respective owners.

Copyright

Copyright © 2005 by Cadex Electronics Inc. All rights reserved. No part of this publication or the firmware controlling Cadex product(s) may be reproduced, transmitted, transcribed, stored in a retrieval system, or translated into any language or computer language in any form or by any means without the express written permission of Cadex Electronics Inc.

Revision Rights

Cadex Electronics Inc. reserves the right to revise this publication and make changes in the contents thereof without obligation to notify any person of such changes. Please contact Cadex Electronics Inc. (service@cadex.com) for suggestions or corrections.

Disclaimer

While every effort is made to ensure that the information contained in this manual is accurate and up-to-date, Cadex Electronics Inc. does not warrant or guarantee the accuracy of the contents of this manual. Further, Cadex makes no warranties, either expressed or implied, as to the merchantability or fitness for a particular purpose of the Cadex **C7000** Series Battery Analyzers (C7200, C7400 and C7400ER) equipment and/or its documentation.

In no event will Cadex or its officers or employees be responsible for any consequential, incidental, or indirect damages (including damages for loss or business profits, business interruption, and the like) arising out of the use or inability to use the Cadex **C7000** Series Battery Analyzers (C7200, C7400 and C7400ER) Battery Analyzer equipment and/or its documentation.

Safety Notice

Use of Equipment

The Cadex **C7000** Series Battery Analyzers (C7200, C7400 and C7400ER) are designed with adequate safeguards to protect the user from shock and other hazards when used as specified within this document. However, if the equipment is used in a manner not specified by this documentation, the protection provided by this equipment may be impaired. Please read this document and equipment labeling before using the equipment.

Modification of Equipment

CE, FCC, CSA and other approvals apply only to Cadex **C7000** Series Battery Analyzers (C7200, C7400 and C7400ER) in the factory-authorized configuration. Changes or modification to the equipment not expressly approved by Cadex will void the approvals and void the user's authority to operate the equipment.

Disposal of Waste Electrical and Electronic Equipment (WEEE) in the European Union

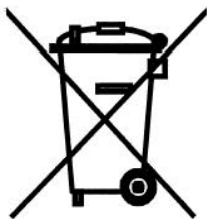

This symbol on the product and package indicates that this product must not be disposed of with unsorted municipal waste. Instead, it is your responsibility to dispose of WEEE by handing it over to a designated collection point for the disposal. The separate collection and recycling of waste equipment will help conserve natural resources and ensure that it is disposed of in a manner that protects human health and the environment. For more information about where you can drop off your waste equipment for disposal, please contact your local municipal office, waste disposal service or wherever you purchased the product.

Radio Interference



This equipment generates, uses and radiates radio frequency energy. If the equipment is not installed and used in accordance with the instructions in this manual, it may cause interference with radio communications. The equipment has been tested and found to comply with the limits for a Class “A” digital device pursuant to Subpart B of Part 15 of the FCC Rules, which are designed to provide reasonable protection against such interference when operated in a commercial environment. Operation of this equipment in a residential area may cause interference, in which case the user is required to take whatever measures needed to correct the interference, at their own expense.

EN55011/EN55022 Warning: This is a Class A product according to EN55011/EN55022. In a domestic environment, this product may cause radio interference, in which case the user, at their own expense, may be required to take adequate corrective measures.

The equipment is designed with adequate safeguards to protect the user from shock and other hazards when used as specified within this document. If the equipment is used in a manner not specified by this documentation, the protection provided by the equipment may be impaired. Please read the documentation and equipment labeling before using the equipment.

The analyzer may be affected by interference from other devices. If the unit is running abnormally, please ensure that the analyzer is moved away from any source of radio interference.

Explosion Hazard



Batteries can burst if treated improperly. Follow these precautions at all times.

- ✓ Clean battery contacts before servicing. To clean battery contacts, use a lint-free cotton swab dipped in 100% isopropyl alcohol.
- ✓ Press the battery firmly into the adapter to ensure a good connection.
- ✓ Ensure that the selected C-code is correct for the chemistry, voltage, and rating of the battery being serviced.
- ✓ Observe battery temperature. Service batteries between 5°C (41°F) and 50°C (122°F). Stop service if battery becomes very hot. The temperatures cited here are the battery temperatures, not ambient the ambient temperatures. Fast charging outside this temperature range may damage or reduce the life of the battery. Allow cold batteries to warm up and hot batteries to cool before charging.
- ✗ Do not attempt to charge non-rechargeable and primary batteries such as alkaline, carbon-zinc, or non-rechargeable lithium batteries.
- ✗ Do not short the positive and negative battery terminals together at any time.
- ✗ Do not connect leads from one station to another, or to the case. An electrical short to any point outside the station bypasses the current regulation loop and may blow a fuse or cause permanent component damage.
- ✗ Do not exceed the battery manufacturer's recommended charge current and voltage limits for batteries.
- ✗ **Do not remove the adapter from the analyzer while the battery is running.**

Charging and Discharging Lithium-ion (Li-ion) Batteries

Lithium-ion (Li-ion) batteries are safe when used as directed. Battery safety cannot be assured when a battery pack is built with individual cells of an unknown nature with a serial and parallel connection. Not all Li-ion cells are suited for multi-cell packs. Only cells that meet tight voltage and capacity tolerances can be used for serial and parallel connection. Mismatched packs are subject to overcharge resulting in venting with flame and fire. Check with the cell manufacturer to see if the cells are suitable for multi-cell packs.

In the past, single Li-ion cells were only available to authorized battery manufacturers. Today, imports are becoming readily available and often fall into the hands of the inexperienced. While most brand name cells are equipped with an internal cell disconnect that permanently opens the current path on high pressure, some brands do not provide this safeguard. Many brands don't use a separator that shuts down the battery when high temperatures are reached. The internal safety features are omitted for cost reasons.



Please follow the following guidelines when charging and discharging lithium-ion cell(s) and packs. Failing to follow these rules could result in venting with flame, explosion, fire and personal injury.

- **Never connect cells in parallel and/or series that are not designed for that purpose. A cell mismatch may overcharge and vent with flames.**
- **Never charge or discharge the battery without connecting a working protection circuit. Each cell must be monitored individually and the current disconnected if an anomaly occurs.**
- **Always attach a temperature sensor when charging and discharging the battery. The temperature sensor must disconnect the current on excess temperature.**
- **Only connect cells that are matched and have the identical state-of-charge.**
- **Pay special attention when using an unknown brand. Not all brands contain intrinsic safety features that protect the cell when stressed.**
- **During experiments, place the test battery into a well-ventilated fireproof container. Never leave the battery unattended while under charge or discharge.**

Shock Hazard



The Cadex Battery Analyzer contains high-voltage circuits, and can pose a shock hazard when the upper cover is removed. Do not attempt to perform any service procedures on the analyzer other than replacement of the external fuse or internal backup battery (see **Chapter 11, Services and Upgrades**, page 114).

- ✓ To reduce the risk of electrical shock hazard, service batteries only when they are removed and disconnected from their end-use equipment.
- ✓ Use the analyzer only as specified in the documentation. Other uses may impair the protection provided by the unit.
- ✓ Use only a grounded AC outlet to power the analyzer.
- ✓ Before attempting any internal service, remove all batteries from the battery stations, turn the analyzer off and disconnect the power cord from the wall socket. Wait a few minutes before opening the cover.
- ✓ Replace fuses only with fuses of the same type and rating (see **Replacing the Primary (Input) Fuse**, page 114).
- ✓ Replace the internal backup battery only with the same type of battery (see **Replacing the Backup Battery**, page 115). Observe the correct polarity when installing the backup battery. Discard the used battery according to the battery manufacturer's instructions.

Warranty & Service

Cadex Electronics Inc. warrants your Cadex Battery Analyzer against defective materials and workmanship for a period of three (3) years from the original purchase date.

The warranty does *not* cover:

- Damage caused by abusive operation, negligence, accident, or improper installation.
- Damage caused by an attempted repair not authorized by Cadex.
- Cosmetic damage caused by normal wear and tear.
- Damage from external causes such as leakage spills, power fluctuations, power failure or inadequate shipping.
- Product received without the appropriate model number, serial number, or safety markings.
- Products used for rental purposes.

Warranty Service

Before sending the unit for service, contact Cadex Technical Support. If your product requires warranty service, the representative will provide a Return Authorization form or number and the location of the nearest service center.

- Ship the product to the service center with freight, insurance, and customs duties prepaid. The Return Authorization form must be included to obtain warranty service.
- Ensure that the unit(s) is properly packed before shipping, preferably in the original Cadex boxes. Damage caused in transit due to improperly packed items is not covered under warranty.
- Products returned from warranty service are shipped with freight prepaid by Cadex.

Non-warranty Repairs

Before sending the unit in for service, contact Cadex Technical Support at 1 800 565-5228. If your product is not covered by warranty, the representative will provide the contact information for the nearest service center. You may contact the service center directly to arrange to send the product in for service. A Return Authorization form or number will be provided only if the product is returning to the Cadex Head Office.

- Ship the product to the service center with freight, insurance and customs duties prepaid.
- Ensure that the unit(s) is properly packaged before shipping.

Note Cadex Electronics Inc. and Cadex authorized service centers require a Purchase Order or written authorization to proceed with repairs.

Table of Contents

- Chapter 1 Overview 1**
 - Product Features..... 1
 - Connecting to Cadex BatteryShop™2

- Chapter 2 Getting Started 1**
 - Contents of the Box 1
 - Using this Manual 1
 - Conventions 3
 - Direction Keys 3
 - Symbols..... 3
 - Abbreviations and Acronyms.....4
 - Commonly Used Terms..... 5

- Chapter 3 Operating Principles..... 7**
 - Components..... 7
 - Front LCD Display Interface..... 10
 - Lights (LEDs)..... 12
 - Menu Structure..... 13
 - Battery Adapters 14

- Chapter 4 Basic Battery Service..... 17**

- Chapter 5 Battery Service Programs..... 22**
 - Basic Programs..... 22
 - Auto 23
 - Charge..... 24
 - Prime 25
 - QuickTest™ 25
 - Advanced Programs 27
 - SelfDCH (Self-Discharge Test) 29
 - Life-Cycle..... 30

DCHOnly (Discharge Only)	31
ExtPrime (Extended Prime)	32
OhmTest	33
RunTime	34
Boost.....	36
Learn.....	37
Q-Learn (Quick Learn).....	39
Custom 1, 2, 3, and 4	41
Battery Service Times	42

Chapter 6 C-codes (Configuration Codes)..... 43

Basic C-code Parameters	44
Program	44
Target Capacity	45
Chemistry.....	45
Battery Voltage (Volts).....	45
Battery Rating (mAh)	46
C-code Setup Name	46
Scaled C-code	46
C-code Matrix	47
Locked C-code.....	47
Extended C-code Parameters	47
Charge Rate (C-Rate).....	47
Discharge Rate (C-rate)	48
Trickle-Charge Rate (NiCd and NiMH only)	49
Recondition Discharge Rate (NiCd and NiMH only).....	49
Capacity Offset	49
Temperature Sensing	50
Negative Slope (NiCd and NiMH only)	51
End of Discharge	51
End of Recondition (NiCd and NiMH only)	52
Charge Method (NiCd and NiMH only).....	53
Maximum Standby Voltage (SLA and Li-ion only).....	53
Maximum Charge Voltage (SLA and Li-ion only)	54
End of Charge (SLA and Li-ion only).....	54
Default Extended C-code Settings	55
Default Extended C-code for NiCd Batteries	55
Default Extended C-code for NiMH Batteries	56
Default Extended C-code for SLA Batteries	56
Default Extended C-code for Li-ion Batteries	57
Extended C-code Settings for Special Cases	57
Intrinsically Safe Batteries	57

Table of Contents

Hawker SLA Batteries	58
Gell SLA Batteries	58
Managing C-codes	58
Select a C-code	58
Display a C-code	59
Change Target Capacity or Program	59
Create or Edit a C-code	59
Add or Edit the C-code Setup Name	61
Reset Extended C-code to the Default settings	62
Delete a C-code	62
Copy a C-code (including QuickTest™ matrix)	63
Copy all C-codes (and matrices) from One Adapter to Another	63
Chapter 7 System Setup And Options	65
Date and Time	65
Company Name	66
Sound Options	66
Voltage Display	68
Battery Service Counter	69
Connecting to BatteryShop™ or a Printer	70
Connecting to BatteryShop™	70
Connecting Devices to the Serial Port	71
Connecting Printers to the Parallel Port (C7400 and C7400ER only)	74
Security	75
Security Level Functions	75
Program Parameters	77
Starting Battery Service	78
Performing an Automatic OhmTest	79
Optimizing Charge Time or Capacity	80
Termination Condition on dT/dt	80
Saving Program and Target Capacity Settings	81
Resuming Service After Power Failure	82
Short Key Functions	84
Chapter 8 Reports and Labels	85
Automatically Print Reports or Labels	88
Automatic Report or Label printing	88
Print Reports and Labels	89
Chapter 9 Events and Data Logs	92

Logging Events.....	92
Setting up the Event Log	92
Using the Event Log	93
Logging Data	95
Sample text strings	98
Setting up the Data Log	99
Using the Data Log	101
Chapter 10 Custom Programs	104
Cycle 1 and Cycle 2	105
Test.....	106
IF Statements	107
THEN and ELSE Statements	108
Phase Done.....	109
Creating and Editing Custom Programs.....	109
Sample Custom Program	111
Chapter 11 Services and Upgrades.....	114
Replacing the Primary (Input) Fuse	114
Replacing the Backup Battery.....	115
Replacing the Station Fuses	119
Upgrading the Firmware.....	120
Resetting the System	120
Cleaning the Analyzer	121
Chapter 12 System Calibration.....	122
Calibrating Voltage	122
Servicing the Voltage Calibration Adapters.....	123
Calibrating Adapters.....	123
Adapter Calibration Values.....	124
Calibration Values for QuickTest™	124
Chapter 13 Solving Problems and Getting Help	126
Troubleshooting.....	126
Manual Updates and Other References.....	130
Technical Support	131

Table of Contents

Appendix A	Messages and Warnings	132
	Non-Coded Messages	133
	By Code	134
	By Detailed Message	137
Appendix B	Charge Algorithms	156
	NiCd and NIMH batteries	156
	SLA and Li-ion batteries	158
Appendix C	Specifications	160
	Hardware	160
Appendix D	Parts and Accessories	162

Chapter 1 **Overview**

The Cadex **C7000** Series of Battery Analyzers includes the C7200, C7400 and C7400ER.

Product Features

- Services rechargeable nickel-cadmium (NiCd), nickel-metal hydride (NiMH), sealed lead-acid (SLA), lithium-ion (Li-ion) batteries and lithium-polymer (Li-Poly). In this manual “Li-ion” refers to both, lithium-ion and lithium-polymer batteries.
- Programmable with a total of 17 programs including:
 - Four basic programs: Auto; Charge; Prime and Quicktest™.
 - Nine advanced programs
 - Four user-programmable programs.
- Battery Adapters allow convenient interface to all battery types. Over 1000 custom battery adapters are available and specialty adapters can be ordered.
- Adapters can be programmed with 10 C-codes. C-Codes contain the chemistry, voltage and rating. Custom adapters are provided with C-Codes of the most common batteries.
- A menu-driven interface with messages in plain English and status lights.
- Prints battery service reports and battery service labels.
- Analyzers can be connected to a PC and operated with BatteryShop™ software.
- BatteryShop™ software allows automated operation and networking of multiple analyzers.

Overview

Connecting to Cadex BatteryShop™

BatteryShop™ is a powerful Windows-based battery management software tool that allows automation of the Cadex battery analyzer functions to increase productivity.

- Provides control and monitoring of large-scale battery services by connecting up to 120 Cadex analyzers to service up to 480 batteries simultaneously.
- Provides easy access to a database of information for over 1000 battery models, including C-code settings. Even a novice user can perform a variety of tests and programs.

To find out how Cadex BatteryShop™ can enhance your battery maintenance system, contact Cadex Electronics Inc (see **Connecting to BatteryShop™**, page 70).

Chapter 2 **Getting Started**

Contents of the Box

The Cadex Battery Analyzer package includes these items:

- One Cadex Battery Analyzer
- One IEC320 Power Cord (North American Version)
- One User's Manual

Using this Manual

The **Cadex C7000 Series Battery Analyzer User's Manual** contains the concepts, procedures and other information necessary to operate the Cadex battery analyzer equipped with firmware version 6.11 (see ***Upgrading the Firmware***, page 120). If you do not have version 6.11, contact Cadex to obtain the upgraded version.)

Chapter 1 - Overview provides basic information about product features and connecting the Cadex analyzer to a computer.

Chapter 2 - Getting Started goes through the items that are included with the analyzer and how the manual works. It also explains common symbols, abbreviations, acronyms and commonly used terms.

Chapter 3 - Operating Principles provides information about the Cadex analyzer, components, display screen, interface and how to use battery adapters with the analyzer.

Getting Started

Chapter 4 - Basic Battery Service provides the basic procedures for servicing a battery.

Chapter 5 – Battery Service Programs provides detailed information about all the battery service programs.

Chapter 6 -C-codes (Configuration Codes) provides detailed information on selecting and managing battery parameters (C-Codes).

Chapter 7 - System Setup and Options describes the analyzer's menu system and provides information about modifying the operation of the analyzer to suit your needs. Refer to this chapter when connecting devices to the analyzer (i.e. printers or a PC with BatteryShop™ software).

Chapter 8 - Reports and Labels provides information about printing battery service reports and labels.

Chapter 9 - Events and Data Logs describes methods of obtaining and graphing detailed voltage/current/temperature/impedance analysis.

Chapter 10 - Custom Programs describes how to create user-defined programs for specialized or advanced applications.

Chapter 11 - Services and Upgrades provides information on servicing the Cadex analyzer, including upgrading the firmware.

Chapter 12 - System Calibration provides instructions for calibrating the analyzer.

Chapter 13 - Solving Problems and Getting Help provides solutions for common problems that may occur when operating the analyzer.

Appendix A - Messages and Warnings provides detailed information on fault codes and messages that appear on the display.

Conventions

Typeface	Meaning
SMALL CAPS	Menu options to select Default settings LCD display text
BOLD SMALL CAPS	Names of keys on the battery analyzer
<i>Italics</i>	Emphasized words
<i>Bold & Italic</i>	References to other sections in this manual

Direction Keys



Direction keys are represented in this manual as follows:

UP = ▲

DOWN = ▼

LEFT = ◀

RIGHT = ▶

Symbols



Caution

Information that, if ignored, can result in damage to the Battery Analyzer, battery adapters or the battery.



Potential shock hazard.



Potential explosion hazard.

Abbreviations and Acronyms

Abbreviation	Name or Term
16k adapters	These adapters have the extra memory to handle matrices for QuickTest™. These adapters are marked “16K” on the rear label.
AWG	American wire gauge (a U.S. wire size standard)
LCD	Liquid Crystal Display (also called <i>display</i>)
LED	Light Emitting Diode (also called <i>light</i>)
Li	Lithium-ion and Lithium-polymer battery chemistry
Li-ion	Lithium-ion battery chemistry
Li-polymer	Lithium-polymer battery chemistry. This chemistry is treated in the same way as Li-ion.
mA	Milli-ampere
mAh	Milli-ampere hour
mOhm	Milli-ohm
NiCd	Nickel-cadmium battery chemistry
NiMH	Nickel-metal-hydride battery chemistry
OEM	Original equipment manufacturer
PC	IBM compatible personal computer
RF	Radio frequency
P/N	Part number
SoC	State of Charge
SoH	State of Health
SLA	Sealed lead acid battery chemistry
USB	Universal Serial Bus

Commonly Used Terms

Term	Explanation
Milliampere Hour (mAh)	Battery capacity or rating. A battery that provides a current of 1000 milliamperes for 1 hour is rated at 1000mAh (or 1Ah).
Battery	A combination of cells.
Capacity	The amount of energy that a fully charged battery is capable of holding.
Configuration Code (C-code)	Battery parameters stored in battery adapters that tell the Cadex analyzer how to service a specific battery type (see Chapter 6 - C-codes (Configuration Codes) page 43).
Cells	Individual items within the battery.
Cycle	One charge and discharge sequence, even if the battery is only partially charged or discharged.
C-Rate	A “C” number is a value that is used to calculate charge and discharge times. A battery rated at 1000mAh provides 1000mA for one hour if discharged at 1C. A discharge of 1C draws a current equal to the rated capacity. The same battery discharged at 0.5C would provide 500mA for two hours.
Battery cycle	A charge followed by a discharge (or a discharge followed by a charge). Even when batteries are partially charged and discharged, a cycle is considered to have occurred.
Intrinsically Safe (I/S)	Batteries with built-in safety protection circuitry. These batteries are used in volatile environments.
Memory	Reversible capacity loss in NiCd and NiMH batteries caused by an increase in the size of crystals formed within the battery.
Matrix	The set of battery parameters for a specific battery model stored during the Q-Learn or Learn process and used for testing batteries of the same model during QuickTest™. A matrix is stored with a C-Code.

Getting Started

Term	Explanation
Recondition	A deep discharge below 1.0V/cell with a controlled current. Reconditioning helps break down large crystals, which develop as a result of memory, to more desirable small sizes often restoring the battery to its full capacity. Applies to NiCd and NiMH only.
Residual Capacity	Capacity remaining in the battery when it is inserted in an analyzer.
Resistance	Also called internal resistance. Opposition to current flow and dissipation of energy in the form of heat.
Self-Discharge	Battery capacity lost during storage because of internal leakage between the positive and negative cell plates.
Smart Battery	Battery equipped with circuits that can communicate with a charger.
State of Charge	The current energy content of a battery.
State of Health	The battery condition that takes into account its capacity, resistance and self-discharge.
Target Capacity	The capacity level (in percentage of manufacturer-stated battery capacity) that a battery must display to pass a test of battery capacity. The target capacity is an arbitrary benchmark set by the user. By default it is set to 80% but it can be changed.
Trickle Charge	Maintenance charge to compensate for battery self-discharge.
User Interface	The front panel of the analyzer that provides information about the status of the analyzer and any batteries being serviced: It consists of the LCD display, the LED indicators and the input keys.

Chapter 3 Operating Principles

Components

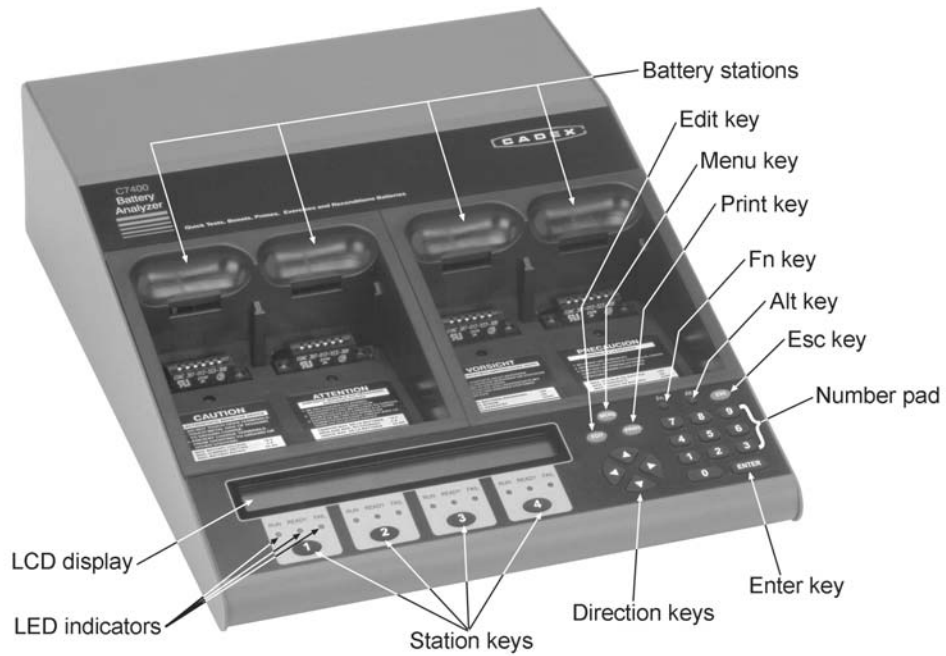

Figure 1: Top and front panel of C7400 & C7400ER battery analyzer

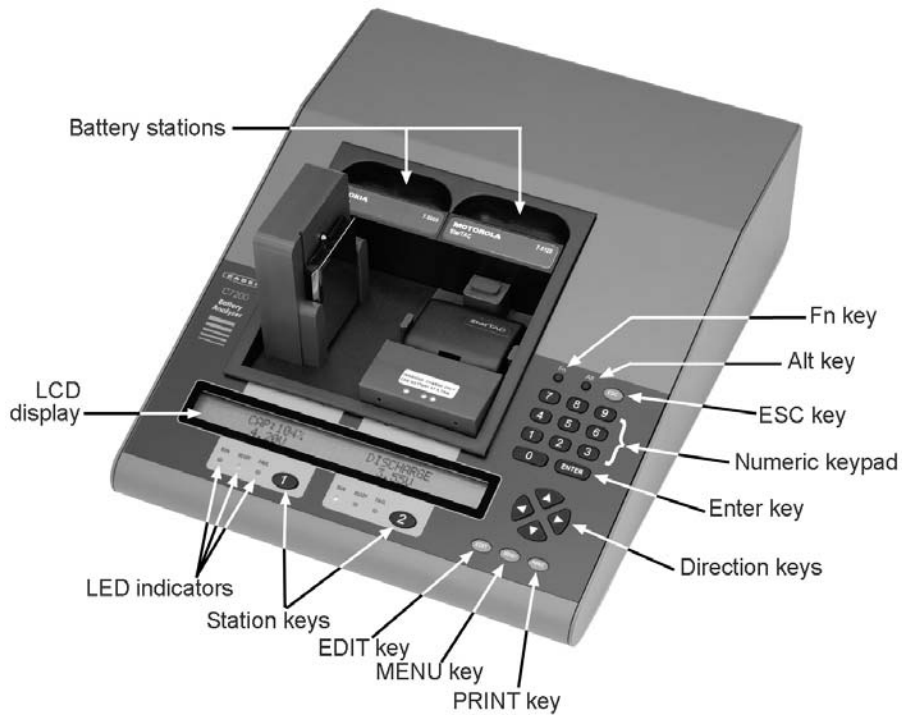

Figure 2: Top and front panel of Cadex C7200 Battery Analyzer

Component	Function
Battery stations	Slots where the battery adapter is inserted. The C7400 and C7400ER has four, the C7200 has two.
Station keys	Displays C-codes or details of a service. The C7200 has two, the C7400 and C7400ER has four
PRINT key	Prints labels and reports.
EDIT key	Edits the C-Code (battery parameters)
ESC key	Used to exit menus, cancel changes, clear detailed displays.
FN key	Provides shortcuts to common functions or special features.
ALT key	Provides access to special services.
ENTER key	To save settings, start battery service and enter sub-menus.
MENU key	To access a list of options to set up the analyzer.
Numeric keypad	To enter passwords or numeric values in a C-Code..

Component	Function
Direction keys	Navigate menus, move between fields, select values, view service details.
LED indicators	View current status of batteries in service (activated when a service starts). Ready (Green): Service complete and/or battery has passed. Fail (Red): Battery service has failed or there is a fault. Run (Yellow): Service in progress.
LCD display	2x40 character screen to display information on each station and its details, to view Menu items.

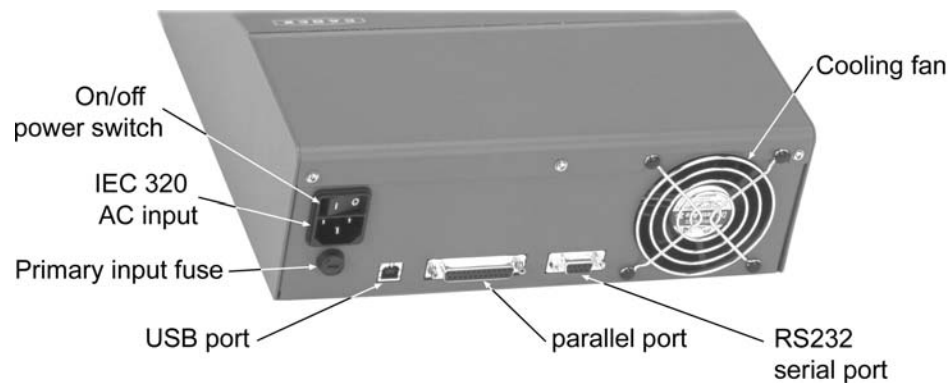

Figure 3: Rear panel of Cadex battery analyzer

Component	Function
On/Off Power switch	To turn the analyzer On and Off.
IEC 320 AC input	Connect the unit to an AC electrical power source with the IEC 320 power cord (North American version supplied).
Parallel port	Not available on the C7200 analyzer. Connects the unit to a printer or label printer.
RS232 serial port (9-pin)	Connects a serial printer or label printer. To connect to the serial port of a computer to upgrade the firmware, to use BatteryShop™ or to monitor data.
USB port	Not available on the C7200 battery analyzer. Not functional with current product firmware.

Component	Function
Cooling fan	Operates continuously to keep the interior of the analyzer at an optimum working temperature. Do not restrict the airflow of the analyzer. Leave the fan opening clear. Fan operation is automatic.
Primary input fuse	Protects the unit from internal short circuits. Can be replaced (see Replacing the Primary (Input) Fuse , page 114).

Front LCD Display Interface

The LCD display has 2 rows with 40 characters on each row. It has three main states:

- The **Global Display** shows the general status of all four stations (or two stations for the C7200) and any batteries being serviced. This is the default view for the C7400 and C7400ER.

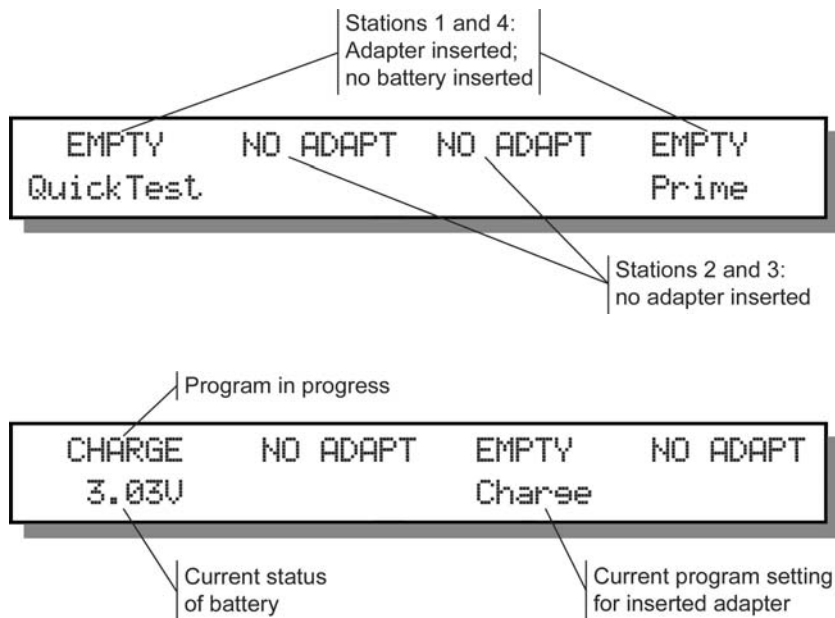

This is the default view for the C7200.

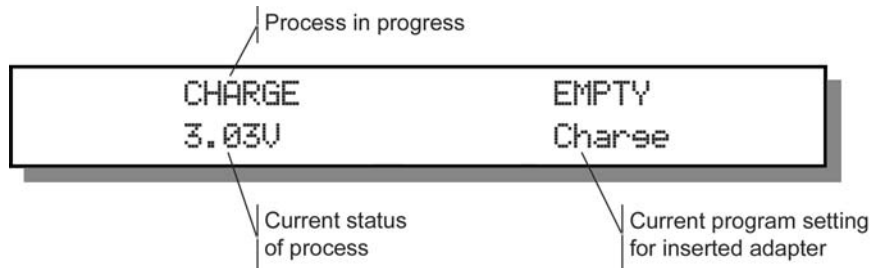
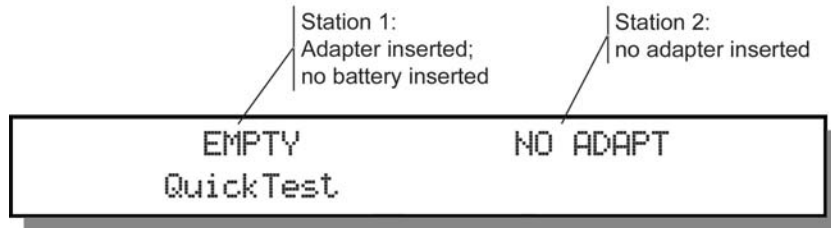

- The **Detailed Display** provides detailed data about one battery service or station when the appropriate station key is pressed. For example, during a service in Station 2, a display similar to this sample appears when you press **2**:

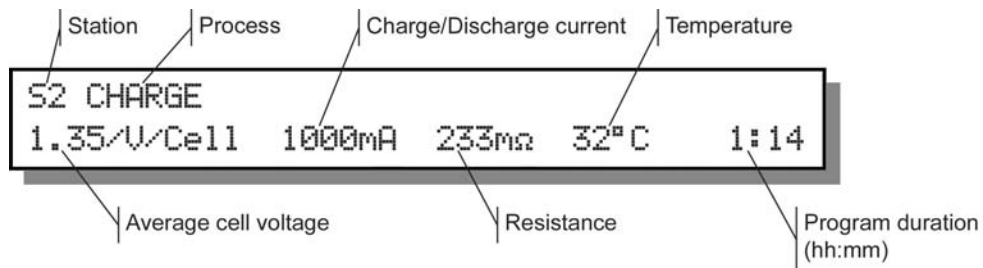

Note Press **▲** or **▼** to display additional details such as warning codes, cycles, and program phases.

- The **Menu Display** provides access to various functions of the analyzer when the **MENU** key is pressed (see **Menu Structure**, page 13).



Press the **MENU** key and select menu functions by pressing **▲** or **▼** to scroll through the menu and pressing **ENTER** when the desired function is displayed. For example, this message shows one option in the System Security menu:

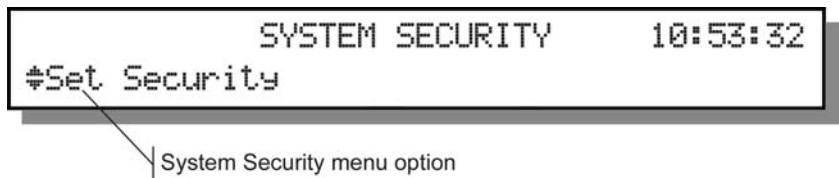

Lights (LEDs)

Light	Status	Explanation
RUN (yellow)	On	Service in progress.
READY (green)	On	Service has completed; Battery has passed the service.
	Flashing	Cold battery. Service resumes when battery warms up (code 12).
FAIL (red)	On	Battery failed.
	Flashing	Hot battery. Service resumes when battery cools (code 13).
All	Flashing randomly	System failed. Turn the analyzer off and then on. Contact Cadex if the condition persists.

Menu Structure

The menu-driven interface allows access to the various functions of the analyzer. See sections on individual functions for details and instructions.

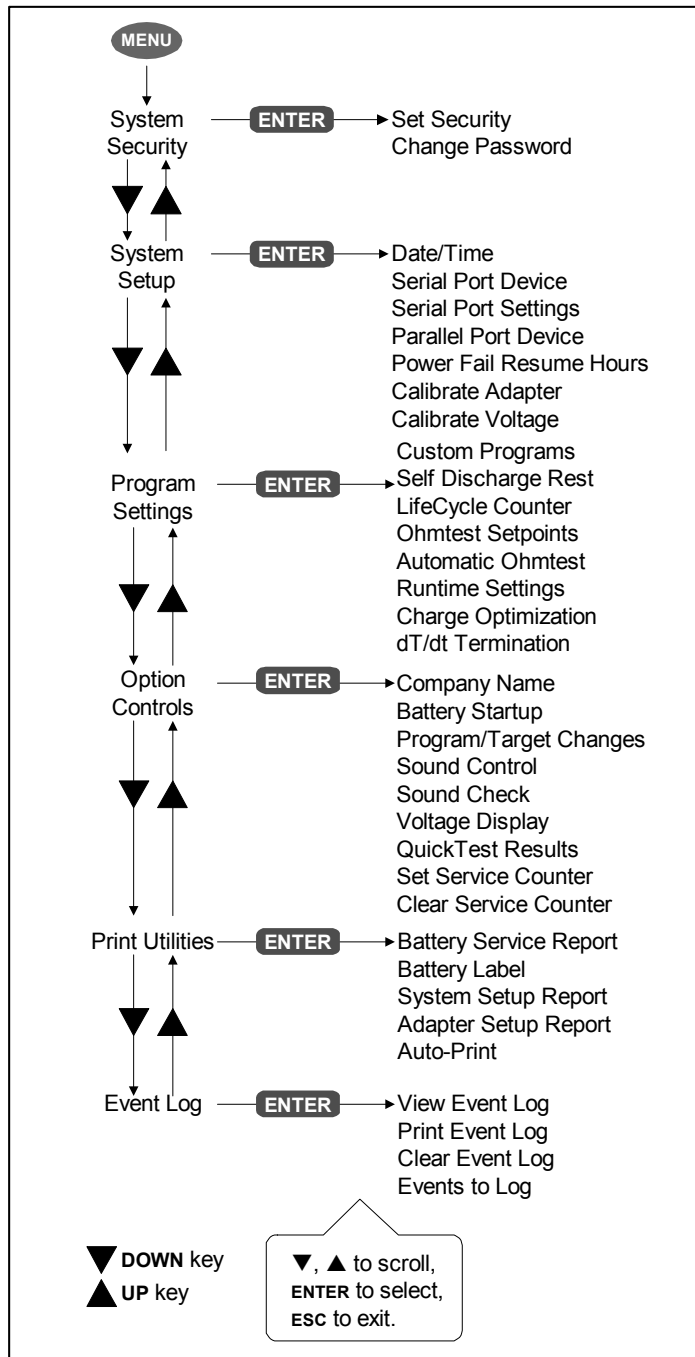

Figure 4: Menu hierarchy of the Cadex Analyzer

Battery Adapters

Adapters are designed to fit specific battery types and shapes. The snap-lock latch allows easy insertion and removal. There are two types of battery adapters:

- **Custom Adapters** accommodate a specific battery shape. There are over 1000 custom adapters available.
- **Universal Adapters** are used when a custom adapter is not available. Pins or alligator clips attach to the positive and negative terminals and include a magnetic temperature sensor.



Figure 5: Different types of battery adapters



ADAPTER HANDLING PRECAUTIONS

- Do not touch the adapter's gold contacts at the rear or on the analyzer station adapter connector. The static charge can damage microcircuits on the adapter.
- Do not remove the adapter from the analyzer while it is servicing a battery. Remove the battery first and then the adapter.
- **ESD HANDLING PRECAUTIONS: When the adapter is NOT**

installed in analyzer:

- **The battery should not be connected to the adapter**
- **Do not allow anything to touch the gold fingers on the adapter connector card**
- **Do not allow anything to touch the adapter connector in the analyzer's adapter well**

Each adapter contains up to ten battery service parameters called Configuration Codes (or *C-codes*) in non-volatile memory. C-codes will not be lost when adapters are removed and reinserted into any station on the analyzer or when the analyzer is turned off.

Custom adapters are pre-programmed with C-codes for the most common batteries. If a battery C-code is not available, you can program a new C-code or reprogram an existing C-code into the analyzer.

Universal adapters, designed for generic batteries, are programmed with blank C-codes and will display NULL CODE when inserted (see **Create or Edit a C-code**, page 59). Battery adapters can be installed, removed or reprogrammed while other stations are being used. Once the adapter is inserted, the battery station receiving the adapter automatically uses the last selected C-code.

Cadex continuously designs and manufactures adapters for new battery models. A list of current battery adapter models is available in the adapter catalog available in print or on the Cadex website. Contact Cadex for a current adapter catalog or download a copy from our web site at www.cadex.com. Cadex also designs custom adapters for a wide variety of applications. A [Battery Adapter Design Form](#) can be downloaded from the Cadex website and used to order a custom adapter.

To insert an adapter

1. Place the empty battery adapter into the battery adapter station, putting the front end in place first.

2. Press down on the back panel (with the label) until the adapter snaps in place.

The LCD display for the station changes from NO ADAPT to EMPTY, indicating that the battery adapter has been inserted but does not contain a battery. The second line of the display indicates the program that was selected in the C-code. If the adapter displays NULL CODE, the C-code has not been programmed, (see **Create or Edit a C-code**, page 59).



OBSERVE POLARITY!

Do not connect the Universal adapter to the battery with the leads reversed or insert the battery into the adapter in reverse.

To remove an adapter

1. **Remove the battery** from the adapter first.
2. Press the latch bar behind the label on the adapter and lift the adapter upwards.

Chapter 4 **Basic Battery Service**

This chapter covers the basic procedures for servicing a battery including: turning on the unit; inserting the battery adapter; selecting the correct C-code and program; inserting the battery; confirming the setting; starting service and recording the results.

To service a battery

1. Turn the power on using the ON/OFF power switch on the rear panel. A boot-up screen appears for 5 seconds: It displays the firmware version on the bottom left (in this case, it is V6.00) and the security level (in this case, it has not been set). This screen can also be cleared after 5 seconds by pressing the **ESC** key.

```
C7200 (C)2000 CADEX ELECTRONICS INC. #
V6.00/1.00 *** DIAGNOSTICS Passed ***
```

2. Insert the battery adapter into a station by sliding the lower-front part of the adapter into the station towards the display. Press the back end down to close with a click. If adapters are inserted in Stations 1 and 4, a display like this appears:

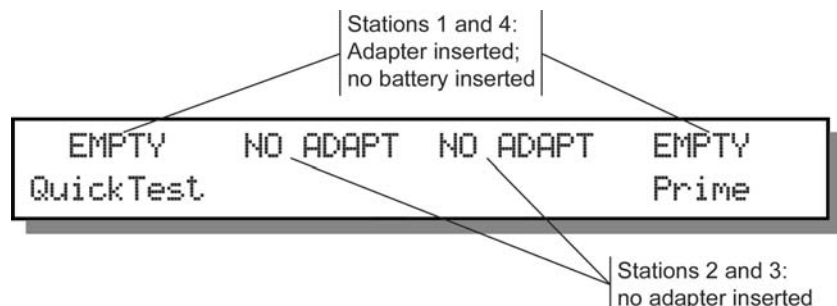

If a Universal adapter is used for the first time, NULL CODE appears on the display. You must create a custom C-code (see **Create or Edit a C-code**, page 59).

3. Insert a battery into the adapter.



BATTERY CONTACTS MUST BE CLEAN BEFORE INSERTING THE BATTERY.

Dirty contacts can increase the resistance in the connection between the adapter and the battery, causing false voltage and current readings and in extreme cases, melting of the contacts. To clean the battery contacts, use a lint-free cotton swab dipped in 100% isopropyl alcohol.

The following message appears when the battery is detected:

```
S1 Press ENTER and verify settings,  
then ENTER again to START
```

Station number

Note You can set up the Cadex analyzer not to display this message and start service (see **Starting Battery Service**, page 78).

If the display continues to display an Empty message, this means that the Cadex analyzer is not recognizing the battery. There are a number of reasons this may happen:

- **Battery is not inserted correctly.** Verify that the battery is correctly and firmly inserted into the adapter. Make sure that the contacts on the battery connect with the contacts on the adapter and check for any switches on the battery.
- **Battery is completely discharged or protection circuits are open.** Run the Boost program by pressing the station key and holding it for two seconds (see **Boost**, page 36).

4. Press **ENTER** to display the C-codes (see Chapter 6 - **C-codes (Configuration Codes)**, page 43).

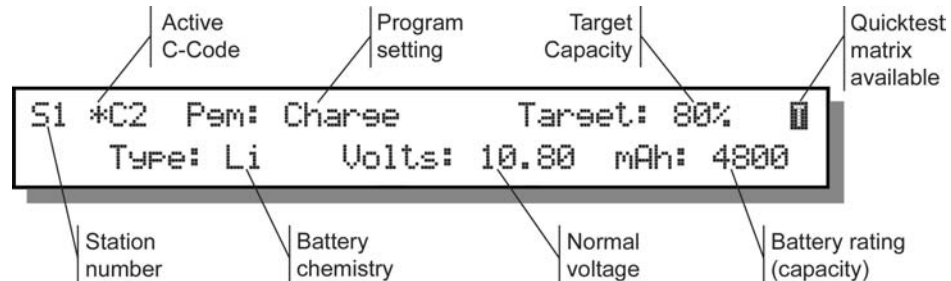

5. If the active C-code (indicated by “*”) is the correct one for the battery you are servicing and all settings in the C-code are correct, go to step 8 to start service otherwise continue to the next step.
6. Select another C-code.
 - a) Press **▲** or **▼** to scroll through the C-codes in the adapter.
 - b) Press **ENTER** when the correct C-code is displayed. Press **ENTER** again to confirm the changes. The selected C-code is now active, and is indicated by “*”.

If you want to change any of the settings in the C-code, you should do it now (see **Create or Edit a C-code**, page 59).



Always use the correct C-code, especially the correct chemistry. Failure to do so may damage the battery or cause fire or explosion.

7. If the C-Code is correct, press **ENTER** to confirm the settings.
8. Press **ENTER** again to start the battery service. The yellow (run) light appears.

Once the service starts, the display will show the current program status as in the following diagram. For detailed information about messages that appear, (see **Appendix A - Messages and Warnings**, page 132).

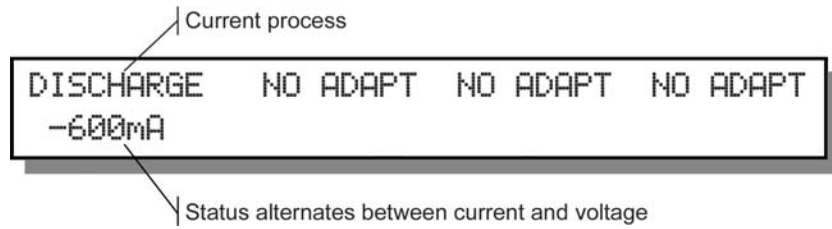

Depending on the battery chemistry and the program selected, service may take anywhere from a few seconds to a few hours. Some programs can take several days or weeks.

If the battery passes after service has completed, the green Ready light comes on. If a battery failed, the red Fail light appears with a Fail code (see **Appendix A - Messages and Warnings**, page 132):

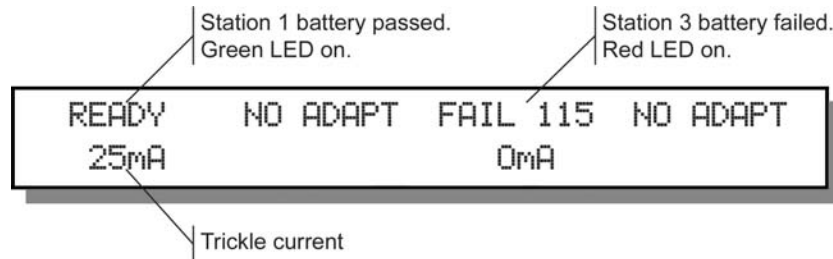

9. To display details about an ongoing or completed battery service:

a) Press the station key to see the detailed display:

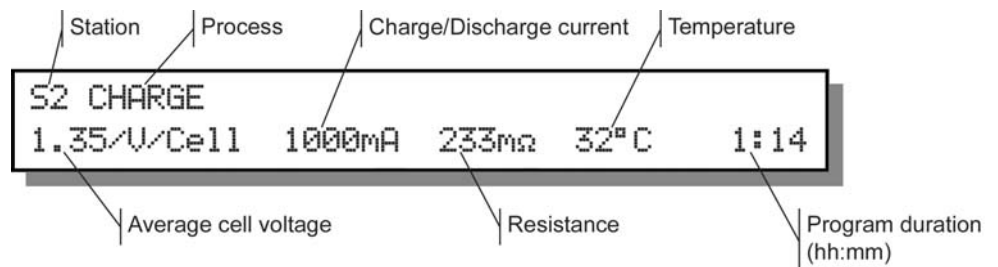

b) Press ▼ to see any applicable warning codes:

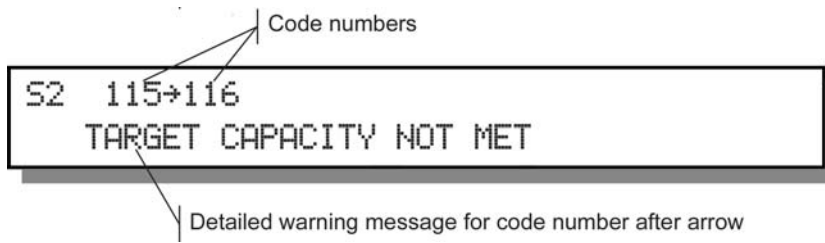

For more information about message codes, including reasons for battery failure and possible solutions (see Appendix A, **Messages and Warnings**, page 132).

c) Press ▼ to see additional information:

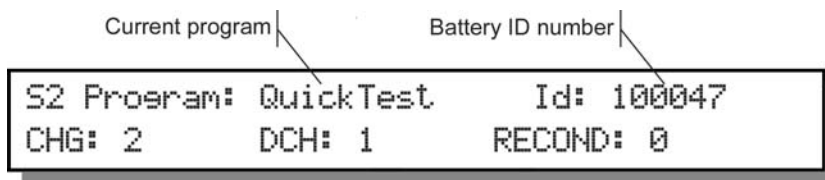

Bottom line shows number of charge, discharge, and recondition cycles run.



REMOVING LARGE BATTERIES WHILE IN SERVICE

It is **NOT** recommended to remove very large batteries while it is in service. Large batteries may create arcs that may degrade the performance of the analyzer. If it is necessary, follow these instructions:

Press and release the Alt key and the station key holding the battery. On the screen that appears, press ▼ to select 'Interrupt' and press Enter. Remove the battery within 5 seconds.

Chapter 5 **Battery Service Programs**

The Cadex analyzer comes with four basic programs, nine advanced programs and four custom programs. These programs measure the battery state of health (SoH), the battery's capacity and find any anomalies that may affect battery performance. If the battery passes the Auto, Prime or Charge service programs, the battery can stay on the charger and stay fully charged until it is used. If the battery fails, the program terminates with the appropriate fault code.

Basic Programs

The basic programs are Auto, Charge, Prime, and QuickTest™ (for 16K battery adapters only). These programs cannot be edited. Each program performs functions for different purposes:

Program	Does this	Is used for this
Auto	Exercises batteries to maintain optimum performance. If the Target Capacity cannot be reached, the battery is reconditioned.	<ul style="list-style-type: none">• Restoring batteries affected by "memory".• Performing routine battery maintenance.• Identifying marginally performing batteries.• Servicing batteries in unknown condition.• Verifying battery condition for warranty claim.
Charge	Applies fast charge only. No capacity readings are taken and no discharge is applied.	<ul style="list-style-type: none">• Charging batteries quickly.• Topping up partially discharged batteries.

Program	Does this	Is used for this
Prime	Repeatedly cycles battery until maximum capacity is reached. If capacity improvement is more than 5% over previous reading, an additional cycle is applied.	<ul style="list-style-type: none"> • Preparing new batteries for field use. • Conditioning batteries that have been in storage.
QuickTest™	Tests battery SoH by comparing battery data to data from other batteries of the same model stored in the QuickTest™ matrix in the C-code.	<ul style="list-style-type: none"> • Gives an estimate of battery SoH to help sort batteries. • 16K battery adapters only (adapters are identified with a “16K” sticker on the back) • A matrix is required to run this program (see <i>Q-Learn Procedure</i>, page 41).

Auto

Function: Exercises batteries to maintain optimum performance. This is the recommended program for routine maintenance of batteries. It reconditions NiCd and NiMH batteries that do not reach Target Capacity. Li-ion and SLA batteries are not reconditioned, only exercised. Batteries in use are typically cycled every three months on Auto. If batteries are failing prematurely, increase the frequency of service on the Auto program.

Sequence: The battery is first cycled (charged and then discharged) to determine it's true capacity. If NiCd and NiMH batteries do not meet the target capacity at the end of the discharge cycle, they are reconditioned to reduce battery memory. Following recondition, the battery is cycled again to determine the recovered or final capacity. The battery is fully charged when the program completes.

SLA and Li-ion batteries are cycled once. If the target capacity is not reached in the first cycle, it is cycled again. Recondition is not performed for Li-ion and SLA batteries.

Results: Global display shows battery capacity as a percentage of manufacturers stated capacity for the battery model. Detailed display shows average battery or cell voltage, analyzer charge or discharge current in mA, OhmTest results, battery temperature (if applicable), and duration of service

Batteries in good condition should be greater than the target capacity (by default this is 80%). If batteries fail, check the fault codes for details.

Duration: Approximately 2.5 to 10 hours for NiCd and NiMH, 20 to 40 hours for SLA and 6 to 20 hours for Li-ion using default C-codes.

Charge

Function: Fast charge a battery.

Sequence: A charge cycle is applied to the battery. No capacity readings are taken (capacity is only obtained if there is a discharge). ***Because Charge does not perform a full analysis, bad batteries may not be caught and can affect a mission critical application. Use the Auto or Prime program to fully diagnose a battery.***

Results: The global display alternates between current average battery, cell voltage and analyzer charge or discharge current (mA) during service and after service. Detailed display also shows OhmTest results, battery temperature (if applicable) and duration of service.

Look for the green Ready LED. It indicates that the battery has been charged. There is no capacity reading taken during a charge. To diagnose faulty batteries the user is required to run Prime, Auto, etc.

Duration: Approximately 1.5 hours for NiCd and NiMH, 10 hours for SLA, and 4 hours for Li-ion using default C-codes.

Prime

Function: Prepares new or stored batteries for use. A new or stored battery may require several charge/discharge cycles to form the cells to achieve peak performance.

Sequence: The program cycles (discharges and charges) the battery until the difference between capacities from one cycle to the next is less than 5%. Up to four cycles are applied until the 5% capacity difference is reached. This allows for batteries that cannot accept a full charge on the first cycle. If the battery is fully discharged, the program starts with a charge. No reconditioning is applied. Some batteries may require several Prime cycles to fully form the cells.

Results: Global display shows final battery capacity percentage. Detailed display shows battery capacity percentages for the last three cycles performed as well as average battery or cell voltage, analyzer charge or discharge current in mA, OhmTest results, battery temperature (if applicable) and duration of service.

Batteries in good condition should be greater than 80% or your target capacity. If batteries fail, check the fault codes for details. If the capacity is low, the battery should be Primed again. In some cases, two or three Prime programs may be required to fully form a battery.

Duration: Approximately 5 to 10 hours for NiCd and NiMH, from 40 to 80 hours for SLA, from 12 to 25 hours for Li-ion using default C-codes.

QuickTest™



This firmware (version 6.11) will not display or use a matrix made with firmware version 5.00 or below. Therefore, you will have to run the Learn program again to create a new matrix. Any old matrix will not be displayed if the adapter is used in version 6.11.

Ensure that battery contacts and adapter contacts are clean. Dirty contacts will affect QuickTest™ readings.

Note: QuickTest is available only when you are using 16k battery adapters. These adapters are marked '16K' on the rear of the adapter.

Function: Before running QuickTest™, create a matrix for the battery using the Learn program (see *Learn*, page 37). QuickTest™ determines the battery SoH (state of health) that is an approximation of the battery capacity and resistance. If a matrix does not exist for the C-code, (i.e. no batteries of the same model have gone through the Q-Learn or Learn programs) a message appears stating that no QuickTest™ matrix has been found, and that the Learn program should be run first. QuickTest™ can still run without a matrix but results are unreliable.

Sequence: The battery is tested to ensure that it has 20% - 90% State of Charge. If not, it applies a charge or discharge for five minutes. The program then performs a sequence of resistance tests, partial charges, discharges and rest. Test results are compared to the matrix to determine the battery state of health.

Results: The Global and detailed display shows the battery condition as “Excellent”, “Good”, “Marginal” or “Poor”. Detailed display also shows average battery or cell voltage, analyzer charge or discharge current in mA, OhmTest results, battery temperature (if applicable) and duration of service.

Duration: Approximately 5 minutes if the battery SoC (state of charge) is between 20% and 90%. Batteries with a lower or higher SoC require additional time to bring their SoC to between 20% and 90%. For most batteries, this takes about 5 minutes. However, with high-capacity batteries, it may take longer.

Advanced Programs

Advanced programs include OhmTest; RunTime; Self-Discharge; Life-Cycling; Discharge Only; Extended Prime; QuickLearn (Q-Learn); Learn; Boost and the four programmable custom programs. Unlike basic programs, some advanced programs have settings that can be edited.

Program	Does this	Is used for this
Self-Discharge	Reads fully charged battery capacity; recharges and reads the capacity after a programmable wait period.	<ul style="list-style-type: none"> Identifying batteries that may have good capacity but have high self-discharge.
Life-Cycle	<p>This is a destructive test that continuously cycles a battery until it fails.</p> <p>Continuously cycles battery until capacity drops below target capacity. Displays initial and final capacity, OhmTest result.</p>	<ul style="list-style-type: none"> Verifying battery life cycle. For example, is for use with a single battery to determine the Life Cycle of an entire batch of batteries. To verify the life of a new constructed cell. Estimating performance time.
Discharge Only (DCHOnly)	Discharges a battery to its end-of-discharge voltage.	<ul style="list-style-type: none"> Determining residual capacity of battery. Preparing batteries for storage. Determining battery performance under load.
Extended Prime	Applies a 16-hour trickle charge, followed by cycling to obtain peak capacity.	<ul style="list-style-type: none"> Preparing new batteries or batteries that have been in extended storage for use.
OhmTest	Tests internal resistance. Passes or fails the battery based on the target resistance.	<ul style="list-style-type: none"> Checking battery condition. Determining if the battery needs to be analyzed further.

Program	Does this	Is used for this
RunTime	Simulates a 5/5/90 discharge. Programmable time and discharge rates per phase.	<ul style="list-style-type: none"> • Testing battery runtime for communications equipment.
Boost	Applies a 100mA trickle charge for 3 minutes.	<ul style="list-style-type: none"> • Reactivating batteries that are not recognized by the Cadex analyzer because of low voltage or an open protection circuit.
Quick Learn (Q-Learn)	This program assumes that a battery has 100% capacity. It profiles the battery and saves the data to the QuickTest™ matrix in the C-code.	<ul style="list-style-type: none"> • Rapidly establishing an accurate QuickTest™ matrix based on the SoH of a new battery that is known to be good. • 16K battery adapters only. (16K adapters have an identifying sticker on the back.)
Learn	Applies a charge-discharge-charge cycle to determine battery capacity, profiles the battery, saves the data to the QuickTest™ matrix in the C-code.	<ul style="list-style-type: none"> • Establishing or modifying QuickTest™ matrix using a spectrum of batteries with various SoH. • Increasing QuickTest™ accuracy (confidence grade) for a given battery type. • 16K battery adapters only. (16K adapters have an identifying sticker on the back.)
Custom 1,2,3,4	Allows the user to create specific programs (see Chapter 10 - Custom Programs , page 104).	<ul style="list-style-type: none"> • Accommodates specialized requirements.

SelfDCH (Self-Discharge Test)

Function: Identifies the self-discharge or the amount of charge a battery loses if it is left alone for a period of time. The standard time is 24 hours.

Sequence: The battery is charged and discharged to obtain its first capacity. The battery is then charged and left for a 24-hour rest period (instructions to change this time are given below). During this time, the battery loses energy through self-discharge. After 24 hours, the battery is discharged to determine the second capacity. The difference between the second and first capacity is the self-discharge.

Results: Press the station key to view the detailed display then press ▲ to view the self-discharge rate (given as a percentage). A battery with low self-discharge has less than 15% self-discharge. A battery that has more than 15% self-discharge may have soft cells and may not be able to provide the required use-time.

Global display shows battery capacity percentage. Detailed display shows battery capacity percentages for the last three cycles performed. It also displays average battery or cell voltage; analyzer charge or discharge; current in mA; OhmTest results; battery temperature and duration of service.

Duration: Approximately 30 hours for a NiCd battery using default C-codes.

To change the Self-Discharge time

1. From the global display, press **MENU**.
2. Press ▲ or ▼ to scroll to PROGRAM SETTINGS, then press **ENTER**.
3. Press ▲ or ▼ to scroll to SELF DISCHARGE REST, then press **ENTER**.
4. Press ▲ or ▼ or use the number pad to select the self-discharge period.

5. Press **ENTER**.
6. Press **▲** or **▼** to scroll to **YES** to accept changes and press **ENTER**.
7. Press **ESC** twice to return to the global display.

Life-Cycle



This is a “destructive” test that continuously cycles a battery until it fails. Do not run this program on a battery you need to use.

Function: Determines total battery life by the number of cycles. Checks whether the battery meets the standard life for its chemistry. This is an accelerated aging test and the battery cannot be renewed after this test.

Sequence: The battery is charged and discharged continuously until the battery fails (i.e. battery capacity falls below target capacity) or the maximum number of cycles has been reached.

Results: Global display shows failure-warning message. Detailed display shows percentage capacity for the first cycle and the last three cycles run. It also displays: average battery or cell voltage; analyzer charge or discharge current (shown in mA); OhmTest results; battery temperature and duration of service.

An additional display screen (press **▲** from detailed display) shows cycle number, percentage of battery capacity achieved and OhmTest results for the first and last cycles run.

Look for the number of cycles (a cycle is a charge followed by a discharge). Batteries should provide the number of cycles as specified by the manufacturer. Typically, with a target capacity of 80%, NiCd batteries should provide about 1500 cycles, NiMH 500 cycles, Li-ion 500 cycles, and SLA 300 cycles.

Duration: Approximately one month or more depending on the chemistry.

To edit the Life Cycle Test settings

The program uses the target capacity set in the C-code to determine when the program should end (see **Target Capacity**, page 45). To terminate the program after a certain number of cycles, do the following:

1. From the global display, press **MENU**.
2. Press **▲** or **▼** to scroll to PROGRAM SETTINGS, then press **ENTER**.
3. Press **▲** or **▼** to scroll to LIFECYCLE COUNTER, then press **ENTER**.
4. Press **▲** or **▼** or use the number pad to select the number of cycles.
5. Press **ENTER**. Press **▲** or **▼** scroll to YES to accept changes and press **ENTER**.
6. Press **ESC** twice to return to the global display.

DCHOnly (Discharge Only)

Function: The DCHOnly program determines the residual capacity of a battery, prepares batteries for storage and checks battery performance under load.

To determine battery capacity, fully charge the battery using the **Charge** program before running the **Discharge only** program.

Sequence: The battery is discharged until its voltage reaches the END OF DISCHARGE setting in the C-code.

Results: Detailed display shows battery capacity as a percentage of manufacturer's stated capacity for the battery model. It also shows average battery or cell voltage; analyzer charge or discharge current (in mA); battery temperature and duration of service. Look for the green ready LED. The battery capacity is measured during a discharge and if the battery is partially discharged, the capacity may be lower than the target capacity. This may give a Fail Code 115 or 116. The battery is not necessarily poor.

Duration: Approximately 1 hour for a NiCd battery discharged at default C-code settings.

To edit the Discharge Only settings

The Discharge Only test settings cannot be edited. However, the program uses the END OF DISCHARGE setting in the C-code (see *End of Discharge*, page 51).



Smart batteries (often used in laptops) should not be stored in a fully discharged state.

If the battery's voltage drops below the level required by the processor within the battery, information can be lost. In some cases, this data loss can leave the battery permanently unusable.

ExtPrime (Extended Prime)

Function: Exercises a battery that has been in storage or unused for a long time (typically three months or more).

Sequence: The battery is charged for 16 hours on the TRICKLE CHARGE setting in the C-code. The battery is then continually cycled (charged and discharged) up to five times until the difference between the capacities achieved from one cycle to the next is less than 5%.

Results: Global display shows final battery capacity percentage. Detailed display shows battery capacity percentages for the last three cycles performed. It also shows average battery or cell voltage; analyzer charge or discharge current (in mA); OhmTest results; battery temperature and duration of service.

Batteries in good condition should be greater than 80% or your target capacity. If batteries fail, check the fault codes for details. If the capacity is low, the battery should be Primed again. In some cases, two or three Prime programs may be required to fully form a battery.

Duration: Approximately 24 hours for a NiCd battery charged and discharged at 1.00 C.

OhmTest



This OhmTest program uses a method similar to the IEC “DC” method to determine the battery resistance. The results tend to be higher than analyzers with firmware version 5.00 and below. Therefore, the OhmTest results cannot be compared with results from analyzers with older firmware versions.

Ensure that battery contacts and adapter contacts are clean. Dirty contacts will affect OhmTest readings.

Ensure battery has a high state of charge (SoC). If battery SoC is less than 50%, OhmTest readings become less consistent.

Calibrate the adapter before performing an OhmTest.

Function: This program is similar to the IEC “DC” method of resistance measurement. It is recommended to have the battery with a high state of charge (i.e. fully charged) to provide values. Low state of charge may produce poor or low values. The OhmTest program determines the internal resistance of a battery and passes or fails the battery based on the OHMTEST SETPOINTS. It provides an estimate of the battery capability to handle load. Setting an OHMTEST SETPOINT is described below.

Sequence: The program tests battery resistance and compares the result with the analyzer’s OHMTEST SETPOINTS for the battery chemistry. If the result is below this threshold, the program fails the battery.

Results: Global display shows internal resistance in milliohms (mΩ). Detailed display also shows average cell voltage; analyzer charge or discharge current (in mA); battery temperature and duration of service.

If the value is above the analyzer’s OhmTest setpoint threshold, the battery fails the OhmTest and should be replaced. If the battery passes, run the Auto or Prime program on the battery to determine whether there are other faults.

Compare several good and bad batteries to determine a suitable OHMTEST SETPOINT. Some industries use 500milliohms as a pass/fail mark.

Duration: 15 seconds for all chemistries.

To edit the OhmTest Setpoint

1. From the global display, press **MENU**.
2. Press **▲** or **▼** to scroll to PROGRAM SETTINGS and then press **ENTER**.
3. Press **▲** or **▼** to scroll to OHMTEST SETPOINTS and then press **ENTER**.
4. Press **▲** or **▼** or use the number pad to set the OhmTest setpoint for the first battery chemistry type.

The default setpoint is 1000mΩ but you can choose any setting between 0 and 4000mΩ.

5. Press **◀** or **▶** to move to the next battery chemistry type.
6. Repeat steps 4 and 5 until the OhmTest setpoint for all battery chemistries are set appropriately.
7. Press **ENTER**.
8. Press **▲** or **▼** to scroll to YES to accept changes and press **ENTER**.
9. Press **ESC** twice to return to the global display.

RunTime

Function: The RunTime program simulates battery run-time by repeatedly running three different loads until the battery reaches the end-of-discharge setting in the C-code. These loads are often called the standby, talk and receive time. You can set the load current (as a percentage of the Discharge Rate) and time (in minutes) for each of the three loads so that the load cycles simulate the equipment in which the battery is used.

Sequence: The battery is charged. The program then repeatedly runs three different loads (see instructions below to set these loads) until the battery is fully discharged (i.e. The end-of-discharge setting in the C-code is reached).

Results: The detailed display shows the battery run-time (hours and minutes). It also shows battery or cell voltage; analyzer charge or discharge current (in mA); OhmTest results; battery temperature and duration of service.

Duration: Approximately 8 – 10 hours for a NiCd battery using default C-codes.

To edit the RunTime settings

1. From the global display, press **MENU**.
2. Press **▲** or **▼** to scroll to PROGRAM SETTINGS and then press **ENTER**.
3. Press **▲** or **▼** to scroll to RUNTIME SETTINGS and then press **ENTER**.
4. The cursor is at Discharge 1 (the first load).
5. Press **▲** or **▼** or use the number pad to set a load between 1 and 100 for the Discharge %. This is a percentage of the Discharge Rate in the C-Code. The default is 100.
6. Press **▶** to move to Minutes – the time this load is applied. Press **▲** or **▼** or use the number pad to set the time between 1 and 59 minutes. The default is 1.
7. Press **▶** to move to the load setting for the Discharge 2 (second phase). Repeat steps 4 and 5.
8. Press **▶** to move to the load setting for the Discharge 3 (third phase). Repeat steps 4 and 5.
9. Press **ENTER** to save the settings.
10. Press **▲** or **▼** to scroll to YES to accept changes and press **ENTER**.

11. Press **ESC** twice to return to the global display.

Boost



Warning!

The Boost program overrides some of the analyzer's built-in safety measures to recognize a battery. Do not attempt to Boost a battery if the polarity, chemistry, voltage and capacity (mAh) are not known. You must also ensure that battery polarity is correct before you attempt to run Boost. For this reason, it is **NOT** recommended to use a Universal Adapter with Boost.

Failure to follow these precautions may result in serious damage to the Cadex unit and/or the battery.

Function: Reactivates batteries with open or shorted protection circuits or with voltage so low that the Cadex analyzer does not recognize them or gives a 'Shorted' (Code 121) message when they are inserted in battery adapters.

Sequence: The battery is trickle-charged for three minutes at 100mA. The Program can be terminated at any time by pressing the Esc key. Look for stable current and voltage readings during the Boost program. If they are intermittent, the battery may be poorly connected, battery protection circuit may be damaged or the battery is inoperable. Normal battery service will start after Boost has reached more than 0.30V/cell on NiCd and NiMH batteries and more than 2.5V for Li-ion batteries. If Boost does not raise the voltage to detectable levels, apply the Boost program again.

Results: If the Boost is successful, the Cadex analyzer recognizes the battery and indicates on the global display that a battery is inserted in the battery adapter.

Duration: 3 minutes (user may repeat if unsuccessful).

To run the Boost program

1. Insert the battery adapter in a battery station.
2. Insert the battery in the battery adapter.

If the battery needs to be boosted, the global display for the station may show one of two things:

- i. It may continue to display the EMPTY message, indicating that the Cadex analyzer has not recognized the battery.
 - ii. It may display a SHORTED (Code 121) message for the battery.
3. Press the station key and hold until a warning message appears reminding you to check battery polarity (about 2 seconds).
 4. If polarity is correct, press ENTER to continue.

Depending on how your analyzer is set up (see *To set user input required by the Cadex analyzer before battery service begins*, page 78), you may need to press ENTER again to accept the C-code settings.

The Boost program starts, and BOOST appears as the active program. The program runs about 3 minutes and provides a 100mA charge.

5. Press ESC any time during the Boost to terminate the program.

If the Boost is successful, the global display changes to the active program name to show that the Cadex analyzer now recognizes the battery.

If the Boost is unsuccessful, you can repeat this procedure until it is successful or until you are convinced that the battery cannot be restored.

To edit the Boost settings

The Boost test program has no settings that can be edited. Boost current is fixed at 100mA for three minutes.

Learn



This firmware (version 6.11) will not display or use a matrix that was made in firmware version 5.00 or below. Therefore, you will have to run

the Learn program again to create a new matrix. Any old matrix will not be displayed if the adapter is used in version 6.11.

Ensure that battery contacts and adapter contacts are clean. Dirty contacts will affect QuickTest™ readings.

Function: Learn creates and stores a modifiable matrix into a C-code for use by QuickTest™.

Sequence: The Learn program applies several charges, discharges and OhmTests to obtain a battery profile. The profile contains the battery's C-code. The C-code is then saved as a matrix used for running the QuickTest™ program.

Results: Detailed display shows three decreasing capacity percentages as well as average cell voltage; analyzer charge or discharge current (in mA); OhmTest results; battery temperature and duration of service. The C-code display screen shows a T in the upper right-hand corner to indicate that a C-code, saved as a matrix, has been stored for using with the QuickTest™ program.

Duration: 4 – 8 hours depending on battery capacity and default C-codes.

Learn Limitations

- Learn is available only on 16K battery adapters. '16K' is marked on the rear label of the adapter.
- Only custom adapters should be used. Universal adapters such as the Universal Alligator Clips Adapter (07-110-0115), the Claw (07-110-0170) and the FlexArm (07-110-0180) are **NOT** recommended. These adapters can create inaccurate results due to resistance errors.
- Learn and QuickTest™ cannot be used with the following batteries:
 - SLA batteries greater than 2Ah (2000mAh).
 - Some 1-cell (1.20V) and 2-cell (2.40V) NiCd and NiMH batteries.
 - Batteries with resistance above 800mΩ (as measured by OhmTest). It is advisable to run an OhmTest to determine battery resistance prior to running the Learn program.

- Batteries that disconnect, reset or give failures while running the Learn program.
- Batteries that cannot accept a charge rate and discharge rate of at least 1.00C. These batteries tend to give errors if they are serviced on the analyzer using the Auto or Prime programs.

Learn Procedure

If you are using a battery that has not been used for two months or more, run the Prime program on the battery prior to running the Learn program.

Calibrate the adapter and ensure that the C-Code for the battery is correct. Take a good battery (over 80% capacity) and run through the Learn program. After the Learn program is complete, take the battery and while it is in the same adapter, run the QuickTest™ program. The final SoH (state of Health) result should be within the range of the actual battery capacity. If not, erase the battery matrix (press FN and then press 2) and start over. Once successful, test other batteries with the same capacity, if possible, to ensure that the SoH readings are within an acceptable range.

To create the most effective matrix, repeat the above steps with more batteries. It is recommended to run the Learn program on at least three batteries: one with a capacity above 90%; one with a 70-80% capacity and finally one at 70% capacity. The batteries can be run through the Learn program in any order.

The battery matrix will be erased if anything in the C-code is changed except for the target capacity and the actual program (i.e Auto, Charge, Prime, QuickTest™ or any of the other programs).

Q-Learn (Quick Learn)

Function: Q-Learn creates and stores a matrix into a C-code for use by QuickTest™. The Q-Learn program is only run once on a battery. For more accurate results, running the Learn program is recommended.

Sequence: This program assumes that the battery has 100% capacity. If a battery has lower capacity, it will not make a correct matrix. The program consists

of a charge and a discharge and the OhmTest. The data obtained from the program profiles the battery's SoH, saving the battery's C-code as a matrix.

Results: Detailed display shows the battery's average cell voltage; analyzer charge or discharge current (in mA); OhmTest results; battery temperature and duration of service. If Q-Learn is successful, the C-code will display a T in the upper right-hand corner to indicate that a QuickTest™ matrix has been created.

Duration: Approximately 5 minutes for all batteries with a SoC (state of charge) level between 20% and 90% of battery capacity. Batteries with a SoC level lower than 20% or greater than 90% require additional time to bring their SoC to between 20% and 90%. For most batteries, this takes an additional 5 minutes but in some cases, especially with high-capacity batteries, it may take longer.

Q-Learn Limitations:

- Q-Learn assumes that the battery's capacity is 100%. If a battery's capacity is less than 100%, it will give erroneous results.
- Q-Learn should only be used for **one** battery. For more accurate results, run the Learn program on three different batteries with varying capacities.
- Q-Learn is available only on 16K battery adapters. '16K' is marked on the rear label of the adapter.
- Only custom adapters should be used. Universal adapters such as the Universal Alligator Clips Adapter (07-110-0115), the Claw (07-110-0170) and the FlexArm™ (07-110-0180) are **NOT** recommended. These adapters will give inaccurate results due to resistance errors.
- Q-Learn and QuickTest™ cannot be used with the following batteries:
 - SLA batteries greater than 2Ah (2000mAh).
 - 1-cell (1.20V) and 2-cell (2.40V) NiCd and NiMH batteries.
 - Batteries with resistance above 800mΩ (as measured by OhmTest). It is advisable to run OhmTest on any battery that is run through the Q-Learn program.
 - Batteries that disconnect, reset or give failures while running the Learn or Q-Learn programs.

- Batteries that cannot accept a charge rate and discharge rate of at least 1.00C. These batteries tend to give errors if they are serviced on the analyzer using the Auto or Prime programs.

Q-Learn Procedure

Calibrate the adapter and ensure that the C-Code for the battery is correct. Take several batteries with 100% capacity or over. Confirm the capacity by servicing the batteries on the Prime program. Note the final capacity and resistance readings. Take the battery with the highest capacity (ensure that it is 100% or greater) and the highest resistance and run this battery through the Q-Learn program. After the Q-Learn program is complete, take the same battery in the same adapter and run it through the QuickTest™ program. The final SoH (state of Health) result should be 100%. If the result is less than 100%, erase the battery matrix (press FN and then press 2) and start over. When a successful result has been obtained (100%), test the other batteries with the same capacity to ensure that the SoH readings are within an acceptable range.

The battery matrix will be erased if anything in the C-code is changed except for the target capacity and the actual program (i.e Auto, Charge, Prime, QuickTest™ or any of the other programs).

Custom 1, 2, 3, and 4

By default, custom programs are blank when the Cadex analyzer is shipped from the factory (see Chapter 10 - **Custom Programs**, page 104).

Battery Service Times

The following table displays the approximate service times at default charge and discharge rates.

	NiCd, NiMH	SLA	Li-ion
Auto	2.5 – 10 hours	20 – 40 hours	6 – 20 hours
Charge	1.5 hours	10 hours	4 hours
Prime	5 – 10 hours	40 – 80 hours	12 – 25 hours
QuickTest™	All chemistries: approximately 5 minutes		
OhmTest	15 seconds	15 seconds	15 seconds
Runtime	Duration depends on settings		
Self-Discharge	30 hours	60 hours	50 hours
LifeCycle	1500 cycles (NiCd) 500 cycles (NiMH)	200 – 500 cycles	1000 cycles
Discharge Only	1 hour	20 hours	4 hours
Extended Prime	21 – 26 hours	56 – 96 hours	28 – 41 hours
Quick Learn	All chemistries: 2-5 minutes		
Learn	All chemistries: 4 – 8 hours		
Boost	All chemistries: 3 minutes		
Custom 1, 2, 3, 4	Duration depends on settings		

Chapter 6 **C-codes (Configuration Codes)**

Battery information such as chemistry, voltage and rating needs to be programmed into the adapter so the analyzer knows how to service A battery. This information is called the *C-code*. Up to 10 C-Codes can be stored on each adapter. Once a C-Code has been entered, the information is stored permanently in the adapter memory where it can be displayed; selected; created; copied; edited and deleted (see ***Managing C-codes***, page 58). The adapter can be moved between stations*and the C-Code remains within the adapter.

Note A C-code cannot be edited or changed while a battery is serviced.

Custom battery adapters come pre-programmed with the most common battery C-codes compatible with the adapter. Universal adapters such as 07-110-0115 (Smart Cable) and 07-110-0180 (FlexArm™) are shipped with no C-Codes and will display NULL CODE when inserted into the analyzer. Create a C-code to clear the NULL CODE message (see ***Managing C-codes***, page 58).

Each C-code is divided into three parts:

- Basic C-codes include program; target capacity; chemistry; voltage and capacity. The C-code setup name, if specified, is displayed on the LCD screen along with basic parameters. If a C-code is locked, scaled or has a matrix, it is indicated on the display by an 'L', 'S' or 'T' respectively. The battery chemistry, voltage and capacity are required in order to start servicing a battery.
- An extended C-code, which consists of charge/discharge C-rate, trickle-charge rate, recondition settings and other parameters are needed to service

* It is recommended to calibrate battery adapters whenever they are moved from one analyzer to another (see *Calibrating Adapters* page 132).

a battery. The types of parameters depend on the battery chemistry described in the following table. In general, extended parameters can be left at their default settings.

- A matrix contains the battery C-Code information for running the QuickTest™ program. Running the Learn or Q-Learn program produces the matrix. Matrix information cannot be seen on the analyzer, however, an inverse T in the top right hand corner of the LCD screen, when the Basic C-code is displayed, will indicate that a matrix has been stored. The matrix is deleted if any part of the C-code, apart from the target capacity or program and is changed (i.e. Auto, Charge, Prime, QuickTest™ or any of the other programs).
- An adapter can save up to 10 C-Codes. Each C-Code is unique and has the following characteristics:

C-Code #	Basic C-Code	Extended C-Code	Matrix
C1	CC1	EEEE1	MMMMMMM1
C2	CC2	EEEE2	MMMMMMM2
C3	CC3	EEEE3	MMMMMMM3
C4	CC4	EEEE4	MMMMMMM4
C5	CC5	EEEE5	MMMMMMM5
C6	CC6	EEEE6	MMMMMMM6
C7	CC7	EEEE7	MMMMMMM7
C8	CC8	EEEE8	MMMMMMM8
C9	CC9	EEEE9	MMMMMMM9
C10	CC10	EEEE10	MMMMMMM10

Basic C-code Parameters

Basic C-code parameters appear on the first detailed screen whenever a battery adapter is inserted in a station and the station key is pressed.

Program

The Program parameter specifies which of the programs is to be run (see Battery Service Programs, page 22).

Target Capacity

The target capacity parameter (displayed as TARGET on the analyzer LCD screen) is displayed as a pass/fail mark. Batteries must achieve the target capacity to “pass”. In the Auto program, if a battery capacity is less than the Target Capacity, the battery is reconditioned.

You can set the target capacity anywhere from 50% to 150% of nominal capacity. These values are recommended for most uses:

- 90% Maintains batteries for critical applications that require maximum energy reserve and high reliability. Fewer batteries will pass.
- 80% Recommended (default) setting that provides a balance between adequate energy reserve and long service life.**
- 70% Recommended for less stringent applications where battery power demand is not critical or is of brief duration. More batteries will pass.

Target capacity is a pass/fail benchmark only. It does not determine the level to which a battery is charged; it only provides an arbitrary point to which to compare actual battery capacity. For example, a battery with a 90% capacity will pass if the target capacity is set at 80% but fail if the target capacity is 100%. The batteries are always fully charged.

Chemistry

The chemistry parameter refers to the battery chemistry. The chemistry is labeled on the battery. The analyzer works with: NiCd (Nickel-cadmium); NiMH (Nickel-metal-hydride); Li-ion (for Lithium-ion and Li-Polymer) and SLA (Sealed Lead Acid). For Lithium Polymer batteries, use Li-ion.

Battery Voltage (Volts)

The Battery Voltage parameter refers to the terminal voltage of the battery. The voltage is often labeled on the battery. On the C7200 and C7400, the maximum voltage is 14.4V for NiCd, NiMH and Li-ion batteries. The maximum voltage is 14V for SLA batteries. The C7200 and C7400 cannot be modified to handle batteries greater than 14.4V. The maximum voltage on the C7400ER is 28.8V for NiCd and

NiMH batteries and 36V for SLA and Li-ion batteries. The voltage is based on a nominal cell voltage of 1.2V/cell for NiCd and NiMH batteries, 2V/cell for SLA batteries, and 3.6V/cell for Li-ion batteries.

On some NiCd and NiMH batteries, manufacturers may rate the voltage based on 1.25V/cell rather than 1.2V/cell. For example, the batteries may have a stated voltage of 7.5V or 12.5V. To obtain the correct voltage, multiply this voltage by 0.96. These voltages are definitions only (in fact, battery voltage varies depending on the state of charge) and do not affect test results. You can also set the Cadex analyzer to display voltage as either 1.2V/cell or 1.25V/cell (see **Voltage Display**, page 68).

Some manufacturers may state the number of cells of their batteries. To get the correct voltage, multiply the number of cells by the chemistry type. For example, the voltage of a 6-cell NiCd would be $6 \times 1.2V = 7.2V$. Use 7.2V on the analyzer.

Battery Rating (mAh)

The battery rating parameter is the nominal capacity or the capacity specified by the manufacturer. These are also indicated on the battery or may be obtained from the manufacturer.

Available settings: 100 – 24,975mAh in increments of 25mAh.

If a battery rating is provided in Watt-Hours (Wh), divide it by the battery voltage to obtain the mAh rating. For example, a 5Wh battery is 0.7Ah (700mAh).

C-code Setup Name

The C-code setup name might be the battery model number or some other name that helps users identify the C-code or the battery it defines. Use **ALT-EDIT** to access the C-code name and **FN-0** to clear the text.

Scaled C-code

Due to the power limitations on the analyzer, if a C-code requires a higher charge or discharge rate than the analyzer is capable of, it automatically scales the C-

code. An inverse S on the top-right hand corner of LCD screen when the basic C-code is displayed will indicate a scaled C-code.

C-code Matrix

When a C-code matrix has been stored to perform a QuickTest™, an inverse T in the top-right-hand corner of the LCD screen will display along with the basic C-code.

Locked C-code

Cadex locks some C-codes at the request of the battery manufacturer. An inverse L on the top-right hand corner of the basic C-code display indicates a locked C-code. These C-codes cannot be edited but they can be deleted.

Extended C-code Parameters

In general, extended C-Code parameters can be left on their default settings. If, however, you are creating or editing C-codes for Smart Cable Adapters or certain types of batteries (for example, intrinsically safe batteries or Hawker SLA batteries), you should pay close attention to the extended C-code parameter settings (see *Extended C-code Settings for Special cases*, page 55).

Charge Rate (C-Rate)

A battery with 1000mAh capacity that is charged at 500mA has a charge C-Rate of 0.50C. A lower charge C-rate reduces the charge current and increases service time. Maximum current is 4000mA (6000mA for the C700ER) for batteries with a stated cell voltage of up to 7.2 V. Maximum current is reduced for batteries with higher nominal voltage. For example, on the C7200, the charge rate for a 14.4V battery will be automatically scaled to 2000mA. An inverse S (scaled C-code) will be displayed on the basic C-code screen.

Discharge Rate (C-rate)

A battery with 1000mAh capacity that is discharged at 500mA is discharged at 0.50C. A lower discharge C-rate reduces the discharge current and increases service time. Maximum current is 4000mA (6000mA for the C7000ER). The discharge rate is reduced for batteries with higher nominal voltage (for example, 2400mA for a 14.4V battery on the C7200). For a single-cell NiCd or NiMH battery, the maximum discharge is 2500mA.

Default Charge and Discharge Rates

NiCd: Standard NiCd batteries up to 1800mAh can be charged and discharged at rate of 1.00C. Cadex recommends a C-rate of 0.70C or 0.50C for batteries above these mAh ratings. The default setting for NiCd is 1.00C. For 1.2V and 2.4V batteries, the default charge rate is 0.30C to maintain normal temperatures.

NiMH: NiMH batteries produce heat during Charge and Discharge. The default charge rate is 0.50C if Temperature Sensing is Disabled. In addition, due to the very fine negative slope, the current is cut in half twice towards the end of the charge cycle to ensure that the battery is fully charged (the current is not reduced if the Charge rate is at 0.10C). If temperature sensing is Disabled, a rest period is applied before the current is cut to allow for the battery to cool. This lengthens the service time. For 1.2V and 2.4V batteries, the default rate is 0.30C to maintain cooling. If the battery gets hot during charge, reduce the Charge rate to 1000mAh or less.

SLA: Battery manufacturers rate the SLA at a 20-hour discharge (0.05C). This slow discharge is not practical when analyzing SLA batteries so the analyzer uses a default 0.30C Charge and 0.10C (10-hour) discharge. Due to this higher discharge rate, the battery will give a lower capacity. Refer to the manufacturers specification for the battery rating at the 10-hour discharge and adjust the battery rating (capacity) or Capacity Offset to compensate for the higher discharge rate.

Li-ion: Most Li-ion (and Li-Polymer) batteries can accept a 1.00C Charge and Discharge rate. This is the default Charge and Discharge Rate.

Trickle-Charge Rate (NiCd and NiMH only)

The Trickle Charge Rate parameter defines the charge level required to maintain the charge on a NiCd or NiMH battery after service is complete.

Available settings: 1% – 10% of the rated capacity.

Default Trickle Charge Rate

The recommended and default rate for NiCd and NiMH is 2%. This rate compensates for any self-discharge and maintains temperature. During Trickle Charge, the battery should remain cool and battery temperature should be less than 5°C above ambient temperature. If the battery feels warm, reduce the trickle charge.

Recondition Discharge Rate (NiCd and NiMH only)

The Recondition Discharge Rate parameter refers to a slow, gradual discharge applied during reconditioning after the battery reaches the end-of-discharge voltage. During this process, the crystalline build-up (memory) on the cell plates dissolves and the battery often restores itself.

Available settings: 2% – 20% of discharge rate setting, in increments of 2%.

Default Recondition Discharge Rate

The recommended Recondition and Discharge default rate for NiCd and NiMH is 12%. This provides the best compromise between speed, effectiveness and safety. The setting is small enough to avoid damage if cell reversal occurs and is large enough to achieve a reasonable, short Recondition Discharge time.

Capacity Offset

The Capacity Offset parameter adds its value to the capacity readings. It is used for SLA batteries to compensate for capacity variation when a battery is discharged at a higher or lower rate than specified by the manufacturer. This

offset is changed based on manufacturer recommendations. It is not mandatory to add the Capacity Offset.

Available settings: -50% to +49%

Default Capacity Offset

SLA batteries are often rated based on a 20-hour (0.05C discharge). This discharge is slow and is not practical when analyzing SLA batteries. The default setting for Discharge is 0.10C (10-hours). Since this is a higher value, the capacity will be less. Refer to the manufacturer specifications for the battery rating at the 10-hour discharge and adjust the Capacity Offset or battery rating (capacity) to compensate for the higher discharge rate. The Capacity Offset merely adds to the capacity if the battery and does not improve battery capacity in any way. The default capacity offset is 00% for all chemistries.

Temperature Sensing

For safety purposes, temperature sensing cannot be disabled for Li-ion batteries. If disabled is selected, temperature is not displayed during service.

The Temperature Sensing parameter defines the temperature range within which the battery is serviced (effective only for batteries or adapters equipped with a temperature sensor). The temperature sensor measures the battery temperature either internally or externally. If battery temperature exceeds the maximum threshold, service is suspended until the battery's temperature drops to 5°C below the threshold. If the battery's temperature is below the minimum threshold, service is suspended and the battery is trickle charged until minimum temperature is reached.

Default Temperature Sensing

Adapters with temperature sensor: 5°C-45°C.

Adapters without a temperature sensor: Disabled (not for Li-ion batteries)

The recommended setting is 5°C-45°C, which is the ideal battery service temperature range. For NiMH batteries, it is recommended to activate temperature sensing to speed up service. If temperature sensing is disabled, the analyzer automatically applies resting periods to allow NiMH batteries to cool down, which lengthens the service time.

Negative Slope (NiCd and NiMH only)

The Negative Slope parameter is a measure of the voltage drop that occurs when the battery reaches full charge. The charge cycle is terminated when the voltage drop reaches the set value.

Available settings: 8mV/cell – 64mV/cell

Default Negative Slope

For 1.2V - 2.4V batteries: 24mV/cell

For 3.6V – 36V batteries: 8mV/cell

Always use the lowest possible negative slope setting. Increasing the negative slope setting delays charge termination causing the battery to heat up at the end of charge. Decreasing the negative slope may terminate charge prematurely if the battery has voltage fluctuations due to instability.

End of Discharge

The End of Discharge is a parameter that is chemistry-dependent. It defines the threshold point at which the discharge cycle is terminated.

Available settings:

- 0.76 – 1.12V/cell (NiCd, NiMH)
- 1.36 – 1.95V/cell (SLA)
- 2.30 – 3.20V/cell (Li)

Default End of Discharge

Most battery-powered devices are designed to operate at the default settings provided below. However, some devices may have a higher or a lower cut-off value, so these values may have to be adjusted if the battery capacity is being compared to the device it's being used in. Refer to the manufacturer settings for these cases.

NiCd and NiMH: 1.00V/cell.

SLA: 1.75V/cell. This value can vary depending on the Discharge rate used. Refer to the manufacturer specifications.

Li-ion: 3.00V/cell. A good number of Li-ion batteries have 2.50V/cell as the End of Discharge setting. Refer to the manufacturer specifications.

End of Recondition (NiCd and NiMH only)

The End of Recondition parameter defines the threshold point at which the reconditioning cycle is complete. This recondition is most effective on NiCd batteries. This threshold point leaves the battery discharged.

Available settings:

- DISABLED
- 0.40 – 0.80 V/cell

Default End of Recondition

The minimum required setting to restore a NiCd battery affected by “memory” is 0.60V/cell. The Cadex analyzer uses 0.40V/cell. SLA and Li-ion batteries cannot be conditioned with a deep discharge.



SMART BATTERIES SHOULD NOT BE RECONDITIONED.

Select **DISABLED** for the End of Recondition when servicing a smart battery.

If the battery's voltage drops below the level required by the processor within the battery, valuable information can be lost. In some cases, this data loss can leave the battery permanently unusable.

Charge Method (NiCd and NiMH only)

This parameter determines how NiCd and NiMH batteries are charged. The reverse load method intersperses discharge pulses during charge and trickle charge to keep batteries cool and promote the recombination of gases.

Available settings:

- DC CHARGE
- NO REV LOAD
- Reverse Load 5% – 12%

Default Charge Method

Best results have been achieved using the default Rev. Load 9%. DC Charge is used for batteries that cannot accept a pulse charge (some intrinsically safe batteries fall into this category). NO REV LOAD is a charge pulse without the reverse pulse.

Maximum Standby Voltage (SLA and Li-ion only)

The Maximum Standby Voltage parameter determines the voltage that SLA and Li-ion batteries are maintained at when fully charged, after service is complete. A charge current of approximately 0.10C maintains the Maximum Standby Voltage. If the battery voltage exceeds the Maximum Standby Voltage, the current is reduced or eliminated until battery voltage drops below the Maximum Charge Voltage. This parameter must be set to be lower than the Maximum Charge Voltage.

Available settings:

- 2.15 – 2.45V/cell (SLA)
- 3.90– 4.35V/cell (Li-ion)

Default Maximum Standby Voltage

SLA: 2.25V/cell

Li-ion: 4.05V/cell

Refer to the manufacturer's specifications for proper settings. If the battery generates heat during prolonged storage on the analyzer after service has been completed, remove the battery from the analyzer.

Maximum Charge Voltage (SLA and Li-ion only)

The Maximum Charge Voltage parameter defines the voltage threshold of SLA and Li-ion batteries that must be maintained until the End of Charge conditions are reached. The charge current drops while the maximum charge voltage is maintained.

Available settings:

- 2.20 – 2.65V/cell (SLA)
- 3.90 – 4.35V/cell (Li-ion)

Default Max. Charge Voltage

SLA: 2.40V/cell.

Li-ion: 4.2V/cell.

Refer to the manufacturer's specifications for proper settings as these values vary depending on the charge rate used and the ambient temperature.

End of Charge (SLA and Li-ion only)

The End of Charge parameter defines the rate of charge the analyzer uses to determine if the battery is fully charged. When the charge current drops below the End of Charge setting while maintaining the Maximum Charge Voltage, the battery is considered fully charged.

The Charge Optimization setting affects the way the end-of-charge setting is used during a charge (see **Optimizing Charge Time or Capacity**, page 80).

Available settings: 0.01 C – 0.10 C

Default End of Charge

SLA and Li-ion: 0.05C. Refer to the manufacturers specification for proper setting as these values vary depending on the charge rate being used. For some batteries, a lower setting is required to ensure adequate charge.

Default Extended C-code Settings

This section lists the default extended C-code parameter values for each of the four battery chemistry types.

Default Extended C-code for NiCd Batteries

Parameter	Default Setting
Charge	1.00 C
Trickle	5%
Discharge	1.00 C
Recondition	12%
Capacity Offset	0%
Temperature Sensing	0°C – 45 C
Negative Slope	8mV/cell, 16mV/cell for 1.2V and 2.4V batteries
End of Discharge	1.00V/cell
End of Recognition	0.40V/cell
Charge Method	Reverse Load 9%

Default Extended C-code for NiMH Batteries

Parameter	Default Setting
Charge	1.00 C
Trickle	2%
Discharge	1.00 C
Recondition	12%
Capacity Offset	0%
Temperature Sensing	0°C – 45 C
Negative Slope	8mV/cell, 16mV/cell for 1.2V and 2.4V batteries
End of Discharge	1.00V/cell
End of Recognition	0.40V/cell
Charge Method	Reverse Load 9%

Default Extended C-code for SLA Batteries

Parameter	Default Setting
Charge	0.30 C
Discharge	0.10 C
Capacity Offset	0%
Temperature Sensing	0 C – 45 C
Max. Standby Voltage	2.25V/cell
Max. Charge Voltage	2.40V/cell
End of Charge	0.05 C
End of Discharge	1.75V/cell

Default Extended C-code for Li-ion Batteries

Parameter	Default Setting
Charge	1.00 C
Discharge	1.00 C
Capacity Offset	0%
Temperature Sensing	0 C – 45 C
Max. Standby Voltage	4.05V/cell
Max. Charge Voltage	4.20V/cell
End of Charge	0.05 C
End of Discharge	3.00V/cell

Extended C-code Settings for Special Cases

This section lists recommended parameter settings for specific types of batteries, where the recommended settings are different from the default settings.

Intrinsically Safe Batteries

Before servicing intrinsically safe (I/S) batteries, set the following C-code parameters as specified:

Parameter	Setting
Charge	0.10 C*
Discharge	0.10 C*
Charge Method	DC charge
End of Discharge	0.96V/cell

* Recommended settings. You can try setting the charge and discharge rates to higher values to speed up servicing; however, if fault codes appear, you must lower the rates.

Hawker SLA Batteries

Before servicing Hawker SLA batteries, set the following C-code parameters as specified below (any parameters not listed here should be left at their default settings):

Parameter	Setting
Discharge	0.40 C
Max. Standby Voltage	2.35V/cell
Max. Charge Voltage	2.60V/cell
End of Discharge	1.62V/cell

Gell SLA Batteries

Use the SLA default settings for Gell batteries.

Managing C-codes

If the ASK FOR BATTERY C-CODE option is set to YES, the desired C-code must be selected and the appropriate parameters entered before a battery is inserted or before battery processing begins (see *To set the user input required by the Cadex analyzer before battery service begins*, page 78).

Note QuickTest™ matrices created by the Q-Learn and the Learn programs are stored in battery adapters as part of the C-code and can be copied to other adapters. However, any change made to the C-code (except target capacity and selected program) erases the stored QuickTest™ matrix.

Select a C-code

1. From the global display, press the station key.
2. Press ▲ or ▼ to scroll to the C-code you want to select.
3. Press ENTER.
4. Press ▲ or ▼ to scroll to YES to accept changes and press ENTER.

5. Press **ESC** twice to return to the global display.

The “*” appears beside the C-code number on the display to indicate that the C-code is active.

Display a C-code

1. From the global display, press the station key.
2. Use the ▲ or ▼ key to scroll to the C-code you want to display. Basic C-code parameters appear on the same screen.
3. Press ◀ or ▶ to scroll through the extended C-code parameters.
4. When you are finished viewing the C-code parameters, press **ESC** once or twice to return to the global display.

Change Target Capacity or Program

1. From the global display, press the station key.
2. Press **EDIT**.
3. Press ▲ or ▼ to scroll to the desired program.
4. Press ◀ or ▶ to move to the target capacity field.
5. Press ▲ or ▼ or use the keypad to enter the desired target value.
6. Press **ENTER**.
7. Press ▲ or ▼ to scroll to **YES** to accept changes and press **ENTER**.
8. Press **ESC** twice to return to the global display.

Create or Edit a C-code

1. From the global display, press the station key.

2. Use the ▲ or ▼ key to scroll to an empty C-code or to the C-code you want to edit.

An empty C-code contains no battery chemistry (TYPE) and VOLTS and mAh are set to 0.

3. Press **EDIT**.
4. Select the program you want to run:
 - a) Press ▲ or ▼ to scroll to the basic program you want to run.
 - b) Press ▶ to select the program and move to TARGET.

Or

- a) Press ▲ or ▼ to scroll through the basic programs to ADVANCED.
- b) Press ▶.
- c) Press ▲ or ▼ to scroll to the advanced program you want to run.
- d) Press ▶ to select the program and move to TARGET.

At any time from this point, you can press **ENTER** to save your changes and stop editing the C-code parameters.

5. Press ▲ or ▼ or use the keypad to enter the required target capacity (see **Target Capacity**, page 45).
6. Press ▶ to move to TYPE.
7. Press ▲ or ▼ to scroll to the appropriate battery chemistry for the C-code.
8. Press ▶ to move to VOLTS.
9. Press ▲ or ▼ or use the keypad to enter the voltage (VOLTS) of the battery to be serviced (see **Battery Voltage (Volts)**, page 45).

10. Press **▶** to move to mAh.
11. Press **▲** or **▼** or use the keypad to enter the battery capacity in milliampere hours (mAh) (see **Battery Rating**, page 46).
12. Press **ENTER**.
13. To leave the extended C-code parameters at the default settings:
 - a) Press **ENTER** again.
 - b) Press **▲** or **▼** to scroll to YES to accept changes and press **ENTER**.

To edit the extended C-code parameters (not usually required):

- a) Press **▶**.
 - b) Edit the extended C-code settings (see **Extended C-code Parameters**, page 47).
 - Press **▶** or **◀** to move between C-code settings.
 - Press **▲** or **▼** or use the keypad to change the settings as required.
 - c) Press **ENTER**.
 - d) Press **▲** or **▼** to scroll to YES to accept changes and press **ENTER**.
14. Press **ESC** twice to return to the global display.

The message CHANGES ACCEPTED appears on the display.

Add or Edit the C-code Setup Name

1. From the global display, press the station key.

2. Press ▲ or ▼ to scroll to the C-code for which you want to edit or add the setup name.
3. Press ALT, and then press EDIT.
4. Press ▲ or ▼ to scroll through upper case letters, lower case letters, punctuation marks, numbers, and a space (which looks like an underscore) to select characters for the setup name.
5. Press ► or ◀ to move the cursor between character positions within the setup name. There are ten positions available.
6. Press ENTER.
7. Press ▲ or ▼ to scroll to YES to accept changes and press ENTER.
8. Press ESC twice to return to the global display.

Reset Extended C-code to the Default settings

1. From the global display, press the station key.
2. Use the ▲ or ▼ key to scroll to the C-code whose extended parameters you want to reset.
3. Press FN and then press 1.
4. Press ▲ or ▼ to scroll to YES to accept changes and press ENTER.
5. Press ESC twice to return to the global display.

(see *Default Extended C-code Settings*, page 55).

Delete a C-code

1. From the global display, press the station key.
2. Use the ▲ or ▼ key to scroll to the C-code you want to delete.

3. Press **FN** and then press **0**.
4. Press **▲** or **▼** to scroll to **YES** to accept changes and press **ENTER**.
5. Press **ESC** twice to return to the global display.

Copy a C-code (including QuickTest™ matrix)

1. Ensure both adapters are inserted in the Cadex analyzer. Neither adapter should contain a battery. The source adapter (the adapter with the C-code to be copied) can also be the target adapter (the adapter that will receive the copied C-code.)
2. From the global display, press the station key for the source adapter.
3. Use the **▲** or **▼** key to scroll to the C-code you want to copy.
4. Press **FN**, and then press **3**.
5. Press the station key for the target adapter. (This can be the same as the source adapter.)
6. Use the **▲** or **▼** key to scroll to the C-code you want to overwrite (usually an empty C-code).

An empty C-code contains no **TYPE** information and **VOLTS** and **MAH** are set to **0**.

7. Press **ENTER**.
8. Press **▲** or **▼** to scroll to **YES** to accept changes and press **ENTER**.
9. Press **ESC** twice to return to the global display.

Copy all C-codes (and matrices) from One Adapter to Another

1. Ensure that both adapters are inserted in the Cadex analyzer. Neither adapter should contain a battery.

2. From the global display, press **FN**, and then press **6**.
3. Press the station key for the station containing the Target adapter.
4. Press **▲** or **▼** to scroll to **YES** to accept changes and press **ENTER**.
5. Press **ESC** twice to return to **the** global display.

Chapter 7 **System Setup And Options**

You can customize a number of global settings on the Cadex analyzer. You can set the date, time, company name, view the event log and print reports or labels.

Date and Time

1. From the global display, press **MENU**.
2. Press **▲** or **▼** to scroll to **SYSTEM SETUP** and then press **ENTER**.
3. Press **▲** or **▼** to scroll to **DATE/TIME** and then press **ENTER**.
4. Enter the date and time information:
5. Press **▶** or **◀** to move between fields (year, month, day, hour, minute, and second).
6. Press **▲** or **▼** or use the number pad to enter the correct date and time information for each field.
7. Press **ENTER**.
8. Press **▲** or **▼** to scroll to **YES** to accept changes and press **ENTER**.
9. Press **ESC** twice to return to the global display.

Note The analyzer is shipped with the date and time set for the Pacific Standard Time (PST) (GMT-8).

Company Name

1. From the global display, press **MENU**.
2. Press **▲** or **▼** to scroll to **OPTION CONTROLS** and then press **ENTER**.
3. Press **▲** or **▼** to scroll to **COMPANY NAME** and then press **ENTER**.
4. Enter the company name:
5. Press **▲** or **▼** to scroll through upper-case letters, lower-case letters, punctuation marks, numbers, and a space (which looks like an underscore) to select characters for the program name.
6. Press **▶** or **◀** to move the cursor between character positions within the program name. There are twenty positions available.
7. Press **ENTER**.
8. Press **▲** or **▼** to scroll to **YES** to accept changes and press **ENTER**.
9. Press **ESC** twice to return to the global display.

Sound Options

The Cadex analyzer uses several sounds to alert users to various events. You can control whether or not sounds are played and you can assign sounds to specific events when the sound control is on.

There are two kinds of events sound alerts can be assigned to. These are **key press** events and **alert events**. When **key press** sounds are on, you hear a click every time you press a key on the Cadex analyzer and you hear one or more tones every time an action or program is completed.

To turn sounds ON or OFF

1. From the global display, press **MENU**.

2. Press ▲ or ▼ to scroll to OPTION CONTROLS, and then press **ENTER**.
3. Press ▲ or ▼ to scroll to SOUND CONTROL and then press **ENTER**.
4. Press ▲ or ▼ to turn the key press sound on (YES) or off (NO).
5. Press ▶ or ◀ .
6. Press ▲ or ▼ to turn the alert sounds on (YES) or off (NO).
7. Press **ENTER**.
8. Press ▲ or ▼ to scroll to YES to accept changes and press **ENTER**.
9. Press **ESC** twice to return to the global display.

To hear sounds assigned to events

1. From the global display, press **MENU**.
2. Press ▲ or ▼ to scroll to OPTION CONTROLS and then press **ENTER**.
3. Press ▲ or ▼ to scroll to SOUND CHECK and then press **ENTER**.
4. Press ▲ or ▼ to scroll to the event for which you want to hear the assigned sound, and press **ENTER**.

The Cadex analyzer plays the sound or tone(s) assigned to the selected event. If you do not hear anything, sounds have been turned off.

5. Repeat step 4 for all events whose assigned sounds you want to hear.
6. Press **ESC** twice to return to the global display.

Voltage Display

You can choose to display voltage as total battery (terminal), voltage (volts) or individual cell voltage (V/Cell). If voltage display is set to V/cell, you must multiply the displayed voltage by the number of cells in the battery to find the voltage for the battery.

On some NiCd and NiMH batteries, manufacturers may rate their batteries based on 1.25V/cell rather than 1.2V/cell. You can specify whether you want voltage displayed as 1.2V/cell or 1.25V/cell, (see **Battery Voltage (Volts)**, page 45).

To set the voltage display mode

1. From the global display, press **MENU**.
2. Press **▲** or **▼** to scroll to OPTION CONTROLS and then press **ENTER**.
3. Press **▲** or **▼** to scroll to VOLTAGE DISPLAY and then press **ENTER**.
4. Press **▲** or **▼** to scroll to the required setting:
 - YES sets the Cadex analyzer to display the voltage of individual cells within the battery (V/Cell).
 - NO sets the Cadex analyzer to display the terminal voltage for the battery as a whole (Volts).
5. Press **▶** or **◀** to move to the NiXX field.
6. Press **▲** or **▼** to select 1.20 or 1.25 volts per cell to display for NiCd and NiMH batteries.
7. Press **ENTER**.
8. Press **▲** or **▼** to scroll to YES to accept changes and press **ENTER**.
9. Press **ESC** twice to return to the global display.

Battery Service Counter

You can program the Cadex analyzer to notify you after it has serviced a specified number of batteries. This can be useful, for example, as a prompt to remind you to perform routine maintenance tasks such as voltage calibration.

You can also restart the count from 0 (zero).

To set the battery service counter

1. From the global display, press **MENU**.
2. Press **▲** or **▼** to scroll to **OPTION CONTROLS** and then press **ENTER**.
3. Press **▲** or **▼** to scroll to **SET SERVICE COUNTER** and then press **ENTER**.
4. Press **▲** or **▼** or use the number pad to enter the number of batteries you want the Cadex analyzer to service before it notifies you.

Set the number to 0 to disable the battery service counter.

5. Press **ENTER**.
6. Press **▲** or **▼** to scroll to **YES** to accept changes and press **ENTER**.
7. Press **ESC** twice to return to the global display.

To restart the battery service count

1. From the global display, press **MENU**.
2. Press **▲** or **▼** to scroll to **OPTION CONTROLS** and then press **ENTER**.
3. Press **▲** or **▼** to scroll to **CLEAR SERVICE COUNTER** and then press **ENTER**.
4. Press **ENTER**.

5. Press ▲ or ▼ to scroll to YES to accept changes and press ENTER.
6. Press ESC twice to return to the global display.

Note This option is not the same as setting the battery service counter to 0. When the service counter is set to 0 using the SET SERVICE COUNTER option, it is disabled. When you use this option to clear the battery service counter, you are restarting the service count from 0.

To display the number of batteries serviced

This option displays both the total number of batteries serviced and the number of batteries serviced in a session (a session is ended when the service counter is cleared).

1. From the global display, press FN, and then press 5.
2. Press ESC to return to the global display.

Connecting to BatteryShop™ or a Printer

The Cadex analyzer has a parallel port and an RS232 DB-9-pin female serial port, which you can use to connect the battery analyzer to a printer, label printer or computer. You may need to use a customized cable to connect to the analyzer. The USB port is only available on the C7400 and C7400ER but it is currently not activated.

Other devices may work with the Cadex analyzer but they are not guaranteed to do so. Cadex is not responsible for any problems or technical support arising from trying to use any printing devices other than those supported.

Connecting to BatteryShop™

To set the analyzer up for BatteryShop™, do the following:

- Connect the cable that is provided with BatteryShop™ to the 9-pin serial RS-232 port on the analyzer. If necessary, use a 25-9 pin converter that is supplied with BatteryShop™ to connect the other end to the PC serial port.
- Change the analyzer from STANDALONE mode to BATTERYSHOP mode,
- Press FN and then press 9 and select TERMINAL.
- Press **ENTER** to save the settings.
- These steps are sufficient to set up the analyzer for use with BatteryShop™. Refer to the BatteryShop™ users manual for details.

Connecting Devices to the Serial Port

The serial port on the Cadex analyzer connects the unit to a computer so you can run BatteryShop™ or transfer service data to a computer. You can also connect supported label printers through the serial port.

The Cadex analyzer supports the following devices on the serial port:

- Dymo-CoStar SE250 or SE300 label printer (choose LABEL MAKER device setting) for printing bar-code labels and battery labels. This is the only label printer that is supported. Use the cable that comes with the printer to connect to the analyzer serial port and set the port to LABEL MAKER. Instructions on setting the port are provided below.
- Set the analyzer to BATTERYSHOP mode to use the unit with BatteryShop™ software. Use the cable that comes with the software to connect to the analyzer serial port and set the port to BATTERYSHOP. Instructions on setting the port are provided below.

Note: To toggle between BATTERYSHOP mode and STANDALONE mode press FN, and then press 9.

- A PC can be used to manually monitor battery data. Use the cable supplied with BatteryShop™ to connect to the analyzer serial port or make one using the configuration described shown in *Typical Serial Cable Pin*

Configurations, page 73. A standard serial cable **will not work**. Set the serial port settings to match the PC port.

The Cadex analyzer offers these settings for the serial port:

Option	Available Settings	Default
Baud Rate	1200, 2400, 4800, 9600, 19200	9600
Handshake	NONE, CTS/RTS, X ON/X OFF	CTS/RTS
Data Bits	7, 8	8
Stop Bits	1, 2	1
Parity	NONE, ODD, EVEN	NONE

To specify and set up the device connected to the Cadex analyzer serial port

1. From the global display, press **MENU**.
2. Press **▲** or **▼** to scroll to **SYSTEM SETUP** and then press **ENTER**.
3. Press **▲** or **▼** to scroll to **SERIAL PORT DEVICE** and then press **ENTER**.
4. Press **▲** or **▼** to scroll to the device to connect to the serial port:
 - Use **BATTERYSHOP** to use the unit with Cadex analyzer BatteryShop™ software.
 - Use **TERMINAL** to connect to a computer you want to use to display and analyze service data (see **Logging Data**, page 95)
 - Use **LABEL MAKER** to connect to a Dymo-CoStar SE300 label printer.
 - Use **PRINTER** to connect to a serial dot matrix Epson compatible printer. Since serial printers are no longer available, use the parallel port or use a SP-2 converter if the parallel port is not available (see Appendix D - **Parts and Accessories**, page 162)
 - **DISABLED** if you do not want to connect a device using the serial port.
5. Press **ENTER**.

6. Press ▲ or ▼ to scroll to YES to accept changes and press **ENTER**.
7. Press ▼ to scroll to SERIAL PORT SETTINGS and then press **ENTER**. This step is not required if connecting to BatteryShop™ or using the Dymo-CoStar SE300 label printer.
8. Enter the required settings as specified in the device user's manual (see above for available options):
 - Press ▶ or ◀ to move the cursor from option to option.
 - Press ▲ or ▼ to scroll through available settings.
9. Press **ENTER**.
10. Press ▲ or ▼ to scroll to YES to accept changes and press **ENTER**.
11. Press **ESC** twice to return to the global display.

Typical Serial Cable Pin Configurations

Note: Do not use these configurations for the Dymo SE300 printer. Use the cable that is supplied with the printer instead.

DB-9 to DB-25				
DB-9		DB-25		
RD	2	—	2	TD
TD	3	—	3	RD
CTS	8	—	4	RTS
RTS	7	—	5	CTS
SG	5	—	7	SG

Note When connecting to a serial printer, it may also be necessary to jumper pins 6 (DSR), 8 (DCD), and 20 (DTR) together on the printer's DB-25 connector. Other jumpers may also be required. Check your printer manual for specific information.

DB-9 to DB-9					
DB-9			DB-9		
RD	2	—	3	TD	
TD	3	—	2	RD	
CTS	8	—	7	RTS	
RTS	7	—	8	CTS	
SG	5	—	5	SG	

Note When connecting to a serial printer, it may also be necessary to jumper pins 6 (DSR), 1 (DCD), and 4 (DTR) together on the printer's DB-9 connector. Other jumpers may be also required. Check your printer manual for specific information.

Connecting Printers to the Parallel Port (C7400 and C7400ER only)

Supported printers can be connected directly to the analyzer's parallel using a parallel cable. You must specify which device is connected to the Cadex analyzer parallel port.

The Cadex analyzer supports the following device on the parallel port:

- Epson-compatible dot matrix parallel printers for printing reports and labels using the Parallel port (choose printer device setting).

To specify the device to connect to the Cadex analyzer parallel port

1. From the global display, press **MENU**.
2. Press **▲** or **▼** to scroll to **SYSTEM SETUP** and then press **ENTER**.
3. Press **▲** or **▼** to scroll to **PARALLEL PORT DEVICE** and then press **ENTER**.
4. Press **▲** or **▼** to scroll to the device you want to connect to the parallel port:
 - Use **PRINTER** to connect to an Epson FX-850-compatible parallel printer.
 - Use **DISABLED** if you do not want to connect a device using the parallel port.

5. Press **ENTER**.
6. Press **▲** or **▼** to scroll to **YES** to accept changes and press **ENTER**.
7. Press **ESC** twice to return to the global display.

Security

The Cadex analyzer offers three security levels for protection against tampering: Level 0 (off), Level 1 (low), and Level 2 (high). Level 0 is the default. Depending on the security level chosen, you may have to enter the password for some features.

A password must have at least three digits.

Security Level Functions

The table below shows functions that require a password at each of the three security levels:

	Functions	Level 0 (Off)	Level 1 (Low)	Level 2 (High)
Services	Start Services	✓	✓	✓
C-code	Edit C-codes	✓	✗	✗
	Select C-codes	✓	✓	✗
System Setup	Change Time/date	✓	✗	✗
	Select Serial and Parallel Port devices	✓	✓	✗
	Perform Calibration	✓	✓	✓
Program Settings	Change Program Settings	✓	✓	✓

	Functions	Level 0 (Off)	Level 1 (Low)	Level 2 (High)
Option Controls	Change Battery startup options	✓	✓	✗
	Change Company name	✓	✓	✗
	Change Sound control options	✓	✓	✗
	Change Voltage display options	✓	✓	✗
Print Utilities	Select battery service report	✓	✓	✗
	Select battery label	✓	✓	✗
	Select System setup report	✓	✓	✗
	Set Auto-print options	✓	✗	✗
	Print All Reports	✓	✓	✓
Event Log	Clear event log	✓	✗	✗
	Set up events to log	✓	✗	✗

To set the level of security

1. From the global display, press **MENU**.
2. Press **▲** or **▼** to scroll to **SYSTEM SECURITY** and then press **ENTER**.
3. Press **▲** or **▼** to scroll to **SET SECURITY** and then press **ENTER**.
4. Press **▲** or **▼** or use the number pad to enter the desired security level (0, 1, or 2).

5. If required, enter the password using the number pad and press **ENTER**.
6. Press **▲** or **▼** to scroll to **YES** to accept changes and press **ENTER**.
7. Press **ESC** twice to return to the global display.

To change the password

1. From the global display, press **MENU**.
2. Press **▲** or **▼** to scroll to **SYSTEM SECURITY** and then press **ENTER**.
3. Press **▲** or **▼** to scroll to **CHANGE PASSWORD** and then press **ENTER**.
4. Enter the old password using the number pad and then press **ENTER**.
5. Enter the new password, and then press **ENTER**.
6. Enter the new password again to confirm and then press **ENTER**.

The message **PASSWORD ACCEPTED** appears on the display if your password change was successful.

7. Press **ESC** twice to return to the global display.

If you lose or forget your password, contact Cadex Technical Support at 1 800 565-5228 ext. 315 with your company name and the serial number of your Cadex analyzer.

Program Parameters

There are a number of settings available that affect the way the Cadex analyzer functions in most or all of its programs.

Starting Battery Service

By default, when you insert a battery in a battery adapter in the Cadex analyzer, you must verify the C-code settings before the service is performed. This verification can be turned off so users can run a battery service as soon as a battery is inserted. You can set the options as follows:

- The Cadex analyzer asks for Battery ID number and asks you to verify settings.
- The Cadex analyzer asks for Battery ID number only.
- The Cadex analyzer asks you to verify C-code settings only (default).
- The Cadex analyzer starts the program in the active C-code without asking for input.

To set user input required by the Cadex analyzer before battery service begins

1. From the global display, press **MENU**.
2. Press **▲** or **▼** to scroll to **OPTION CONTROLS** and then press **ENTER**.
3. Press **▶** or **◀** to scroll to **ASK FOR BATTERY ID #**
4. Press **▲** or **▼** to scroll to the required setting:
 - **YES** sets the Cadex analyzer to ask for the Battery ID number.
 - **NO** (default) sets the Cadex analyzer not to ask for Battery ID number.
5. Press **▶** or **◀** to scroll to **ASK FOR BATTERY C-CODE**
5. Press **▲** or **▼** to scroll to the required setting:
 - **YES** sets the Cadex analyzer to ask the user to verify C-code settings.

- NO (default) sets the Cadex analyzer not to ask for the battery C-code.
6. Press **ENTER**.
 7. Press **▲** or **▼** to scroll to accept changes and press **ENTER**.
 8. Press **ESC** twice to return to the global display.

Performing an Automatic OhmTest

Every time the Cadex analyzer runs a charge cycle, it can automatically perform an OhmTest on the battery as well (except when the charge cycle is being performed as part of a custom program). You can choose whether or not to perform the automatic OhmTest.

Note Automatic OhmTest cannot be turned on or off using the following programs: QuickTest™, Q-Learn, Learn and Life-Cycle. OhmTest is included in these programs and the settings cannot be changed.

To turn Automatic OhmTest on or off

1. From the global display, press **MENU**.
2. Press **▲** or **▼** to scroll to PROGRAM SETTINGS and then press **ENTER**.
3. Press **▲** or **▼** to scroll to AUTOMATIC OHMTEST and then press **ENTER**.
4. Press **▲** or **▼** to scroll to the required setting:
 - YES (default) sets the OhmTest to run automatically before every charge cycle (except during custom programs).
 - NO turns off the automatic OhmTest.
5. Press **ENTER**.
6. Press **▲** or **▼** to scroll to YES to accept changes and press **ENTER**.

7. Press **ESC** twice to return to the global display.

Optimizing Charge Time or Capacity

The end of charge conditions can be modified, (see Appendix B – **Charge Algorithms**, page 156).

To select the charge optimization option

1. From the global display, press **MENU**.
2. Press **▲** or **▼** to scroll to PROGRAM SETTINGS and then press **ENTER**.
3. Press **▲** or **▼** to scroll to CHARGE OPTIMIZATION and then press **ENTER**.
4. Press **▶** or **◀** to move to between NiCd AND NIMH OPTIMIZATION and SLA AND LI OPTIMIZATION:
5. Press **▲** or **▼** to the required setting (see Appendix B – **Change Algorithms**, page 156)
 - TIME (default).
 - CAPACITY.
6. Press **ENTER**.
7. Press **▲** or **▼** to scroll to YES to accept changes and press **ENTER**.
8. Press **ESC** twice to return to the global display.

Termination Condition on dT/dt

The Termination Condition on dT/dt parameter sets the temperature a battery can reach before it will terminate or reduce the charge current. If a battery temperature rises more than the dT/dt the charge current is either reduced or charge is completed (see Appendix B – **Charge Algorithms**, page 156).

To select the charge optimization option

1. From the global display, press **MENU**.
2. Press **▲** or **▼** to scroll to PROGRAM SETTINGS and then press **ENTER**.
3. Press **▲** or **▼** to scroll to DT/DT TERMINATION and then press **ENTER**.
4. Press **▲** or **▼** to the required setting (see Appendix B – **Charge Algorithms**, page 156)
 - 2°C RISE PER: 2 MINUTES
 - 2°C RISE PER: 3 MINUTES (default)
 - 2°C RISE PER: 4 MINUTES
5. Press **ENTER**.
6. Press **▲** or **▼** to scroll to YES to accept changes and press **ENTER**.
7. Press **ESC** twice to return to the global display.

Saving Program and Target Capacity Settings

By default, when you make changes to program and target capacity settings, they are saved as part of the C-code stored in the battery adapter.

You can choose to have the Cadex analyzer save these changes to the battery station rather than to the C-code. Settings saved to the station are independent of setting battery adapter inserted in the station. Program and target capacity settings programmed into the analyzer station will override the C-codes programmed in the adapter.

Saving program and target capacity is useful if you have several Cadex analyzer units and want to dedicate a unit to one or two specific programs and target capacities.

To set the method of saving changes to program and target capacity

1. From the global display, press **MENU**.
2. Press **▲** or **▼** to scroll to OPTION CONTROLS and then press **ENTER**.
3. Press **▲** or **▼** to scroll to PROGRAM/TARGET CHANGES and then press **ENTER**.
4. Press **▲** or **▼** to scroll to the required setting:
 - C-CODE (default) saves any changes made to the program settings or the target capacity to the active C-code.
 - STATION saves any changes made to the program settings or the target capacity to the battery station. These changes override any settings in the active C-code.
5. Press **ENTER**.
6. Press **▲** or **▼** to scroll to YES to accept changes and press **ENTER**.
7. Press **ESC** twice to return to the global display.

Note If you want to use all of the settings from the active C-code, this option *must* be set to C-CODE. Setting it to C-CODE will erase all settings saved to the stations.

Resuming Service After Power Failure

If there is a power failure, the back-up memory in the analyzer keeps service data for one hour. If the power failure lasts less than an hour, battery service resumes from where it left off. If the power failure lasts longer than one hour, the battery resumes from the beginning. This time can be modified:

To change the Power Failure Resume Hours

1. From the global display, press **MENU**.

2. Press ▲ or ▼ to scroll to SYSTEM SETUP, press **ENTER**.
3. Press ▲ or ▼ to scroll to POWER FAILURE RESUME HOURS, press **ENTER**.
4. Press ▲ or ▼ to scroll to the required setting:
5. Press **ENTER**. Press **ENTER** again to save the settings.
6. Press **ESC** twice to return to the global display.

Short Key Functions

Common functions can be set with the **Fn** or **Alt** with number key.

From Edit Display		From Global Display	
Fn-0	Deletes C-Code	Fn-5	Views Service Counter
Fn-1	Resets extended C-Code to default settings	Fn-7	Views Firmware Version
Fn-2	Erases QuickTest™ matrix	Fn-8	Calibrates Station
Fn-3	Copies single C-Code	Fn-9	Toggles between stand alone and BatteryShop™ mode
Fn-6	Copies all C-Codes from one adapter to another	Alt-0	Resets defaults and restarts unit
Fn-9	Protects a Matrix from changes. Indicated by 'P' in C-Code	Stn Key	3 second key press starts Boost
Alt-Edit	Enters unique names for C-Codes	Alt-Stn Key	Select 'Restart' to restart service. Select 'Interrupt' – the station will interrupt to remove a battery while it is in service.

The Cadex analyzer prints labels and service reports. using either Auto-Print or Manual settings. When Auto-Print is active, a label or service report will print immediately after servicing the battery, when the battery is removed from the analyzer. When the battery is removed, the label or service report is printed and the station will reset (the service information will not be saved). Manual print settings allow you to print a label or service report after a battery is serviced and before it is removed from the analyzer. The Cadex analyzer supports specific types of printers (see ***Connecting to BatteryShop™ or a Printer***, page 70). In order to use other types of printers or save service data, Cadex recommends using BatteryShop™.

There are three reports available:

- The **Battery Service Report** includes: the battery ID number; detailed status information; battery parameters (including chemistry, number of cells, rating, and cell voltage); the C-code description; the cycles performed on the battery; charge and discharge rates; any applicable fault codes and final capacities. For a sample battery service report see ***Figure 6***, page 87.
- The **System Setup Report**. includes: the time; date; company name; serial port settings; device selected; event log setup; adapter setup and custom program information (the System Setup Report must be printed on a dot-matrix printer).
- The **Adapter Setup Report** report includes: the adapter header information; each C-code and program stored in the adapter and all parameter settings (the Adapter Setup Report must be printed on a dot-matrix printer).

There are also two types of labels:

- **Battery ID label.** This label contains the company name; date of service; test results with any fault codes and the battery ID number (if the battery ID has been programmed into the program parameters). The label is attached to the battery after it is serviced.
- **Bar-code label.** This label contains a bar code representing either the battery ID number or the C-code. For samples of bar code and battery labels, see *Figure 7*, page 88.

BATTERY SERVICE REPORT

Company: CADEX ELECTRONICS
Date: 01/19/2000
Time: 16:47:11

BATTERY STATUS

Battery: STATION 2
Battery ID: 1234567890

Current Cycle: PROCESS COMPLETE
Cycle Capacities: 30% 82% 98%
Battery Resistance: 122m Ω
Cell Voltage: 3.91V/cell
Charge Cycles: 3
Discharge Cycles: 3
Recondition Cycles: 0
Elapsed Time: 0 Days 6 Hours 40 Minutes

BATTERY PARAMETERS

Battery C-Code: 40-02-016:0505-505-3407
Program: Auto
Target Capacity: 80%

Battery Type: 42 - Lithium Ion
Number of Cells: 2 (7.2V)
Battery Rating: 400mAh

Charge Rate: 0.50C (200mA) Max. Charge Voltage: 4.10V/Cell
Discharge Rate: 0.50C (200mA) End Discharge: 4.10V/Cell
End of Charge: 0.10C (40mA) Max. Standby Voltage: 4.05V/Cell
Capacity Offset: 0% Temperature Sensing: 5°C - 45°C

FAULT CODES

FINAL STATUS

Ready

Figure 6: Battery service report

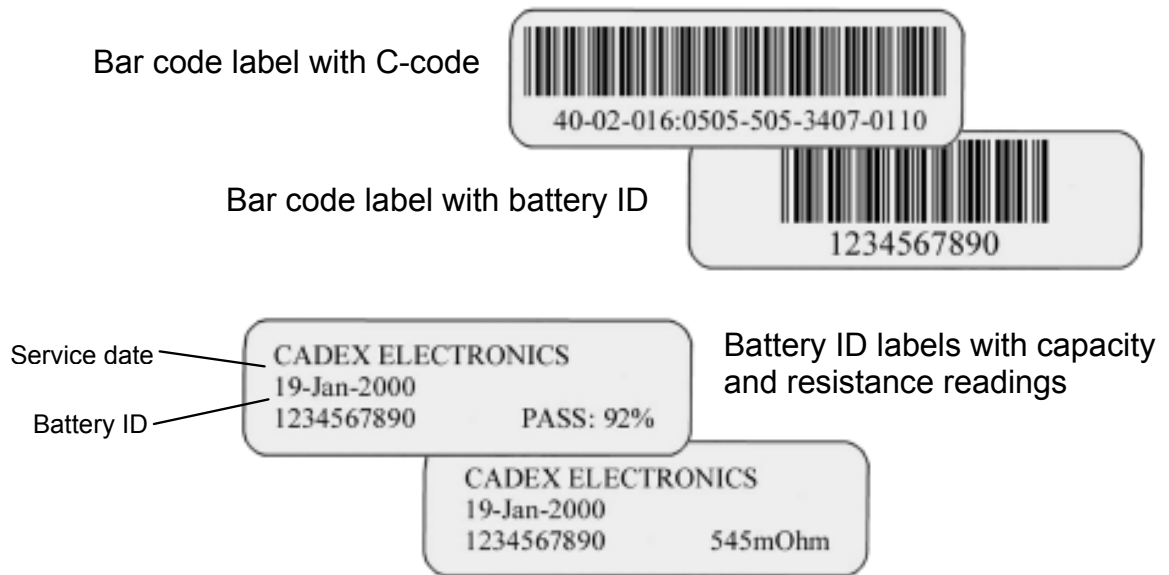

Figure 7: Battery ID and bar code labels

Automatically Print Reports or Labels

You can set up the Cadex analyzer to print battery service reports or battery labels automatically whenever a battery is removed from an adapter after servicing.

Automatic Report or Label printing

1. Make sure you have connected a printer or a label printer to the Cadex analyzer's parallel port or serial port and made any required changes to the serial port settings (see **Connecting to BatteryShop™ or a Printer**, page 70).
2. From the global display, press **MENU**.
3. Press **▲** or **▼** to scroll to **PRINT UTILITIES** and then press **ENTER**.
4. Press **▲** or **▼** to scroll to **AUTO-PRINT** and then press **ENTER**.

5. Press ▲ or ▼ to scroll to LABEL or REPORT, as required. If you want to cancel automatic printing, scroll to NEITHER.
6. Press ENTER.
7. Press ▲ or ▼ to scroll to YES to accept changes and press ENTER.
8. Press ESC twice to return to the global display.

Print Reports and Labels

If you don't have the Cadex analyzer set up to print battery labels or battery service reports automatically, you can still print them for individual batteries that have been serviced. You can also print bar-code labels for individual batteries.

Note Before you can print any report or label, a printer or label printer must be properly set up and connected to the parallel port or the serial port of the Cadex analyzer (see *Connecting to BatteryShop™ or a Printer*, page 70).

Tip You can also print reports and labels by selecting that option from the menu under PRINT UTILITIES.

Print a battery service report

1. Perform the required service on the battery. Do not remove the battery from the adapter.
2. Press PRINT.
3. Press the station key of the station that contains the battery.
4. Press ▲ or ▼ to scroll to BATTERY SERVICE REPORT.
5. Press ENTER.

Print an adapter setup report

1. Press **PRINT**.
2. Press the station key of the station that contains the battery.
3. Press **▲** or **▼** to scroll to **ADAPTER SETUP REPORT**.
4. Press **ENTER**.

Print a system setup report

1. From the global display, press **MENU**.
2. Press **▲** or **▼** to scroll to **PRINT UTILITIES** and press **ENTER**.
3. Press **▲** or **▼** to scroll to **SYSTEM SETUP REPORT** and press **ENTER**.

Print a battery label

1. Perform the required service on the battery. Do not remove the battery from the adapter.
2. Press **PRINT**.
3. Press the station key of the station that contains the battery.
4. Press **▲** or **▼** to scroll to **BATTERY LABEL**.
5. Press **ENTER**.

Print a label with a battery ID bar code

1. Perform the required service on the battery. Do not remove the battery from the adapter.
2. Press **PRINT**.
3. Press the station key of the station that contains the battery.

4. Press ▲ or ▼ to scroll to ID # BAR CODE LABEL.
5. Press ENTER.

Print a label with a bar code for the active C-code

1. Press PRINT.
2. Press the station key of the station that contains the battery.
3. Press ▲ or ▼ to scroll to BAR CODE FOR ACTIVE C-CODE.
4. Press ENTER.

Logging Events

The event log stores data concerning the fifty most recent eligible events. This allows tracking of general battery service trends as well as identification of potential problems.

DATE	TIME	STN	CODE	DESCRIPTION
01/18/2000	14:07	0	200	POWER ON
01/18/2000	14:07	0-1	201	ADAPTER INSERTED
01/18/2000	14:07	0-2	201	ADAPTER INSERTED
01/18/2000	18:57	0-1	115	TARGET CAPACITY NOT MET
01/18/2000	19:00	0-1	26	BATTERY REMOVED
01/19/2000	10:25	0-2	18	PROCESS SUSPENDED
01/19/2000	10:25	0-2	188	SUSPENDED PROCESS ABORTED
01/19/2000	10:25	0-2	17	BATTERY REMOVED

Figure 8: Sample event log

Setting up the Event Log

There are several types of events that the Cadex analyzer can log.

Event	Description
Errors	Problems that stop the service.
Warnings	Problems that do not stop the service, but may affect battery performance.
System Events	Events recorded by the system.
Battery Events	Completed actions or programs in a battery service cycle.
Battery Cycles	Detailed events in a battery service cycle.

Event	Description
Echo to Printer	Instruction to send events to the printer.

You can specify which of these events to include in the event log.

To set up the types of events to be logged

1. From the global display, press **MENU**.
2. Press **▲** or **▼** to scroll to **EVENT LOG** and then press **ENTER**.
3. Press **▲** or **▼** to scroll to **EVENTS TO LOG** and then press **ENTER**.
4. For each event type:
 - a) Press **▲** or **▼** to scroll to **YES** to include it in the event log or **NO** not to include it.
 - b) Press **▶** to move to the next event type.
5. Press **ENTER** when you have set up all events to be logged.
6. Press **▲** or **▼** to scroll to **YES** to accept changes and press **ENTER**.
7. Press **ESC** twice to return to the global display.

Using the Event Log

If you have a printer connected to the serial port of the Cadex analyzer, you can print the event log. Alternatively, you can display the 50 most recently logged events on the LCD display.

At any time, you can clear all events from the event log.

To print the event log

1. Make sure you have connected a printer to the serial port of the Cadex analyzer and made the appropriate changes to the serial port settings (see ***Connecting to BatteryShop™ or a Printer***, page 70).
2. From the global display, press **MENU**.
3. Press **▲** or **▼** to scroll to **EVENT LOG** and then press **ENTER**.
4. Press **▲** or **▼** to scroll to **PRINT EVENT LOG** and then press **ENTER**.

To display the event log on the LCD display

1. From the global display, press **MENU**.
2. Press **▲** or **▼** to scroll to **EVENT LOG** and then press **ENTER**.
3. Press **▲** or **▼** to scroll to **VIEW EVENT LOG** and then press **ENTER**.
4. Press **▲** or **▼** to scroll through the events in the log.
5. Press **ESC** when you are finished viewing the log events.
6. Press **ESC** twice more to return to the global display.

To remove all logged events from the event log

1. From the global display, press **MENU**.
2. Press **▲** or **▼** to scroll to **EVENT LOG**, and then press **ENTER**.
3. Press **▲** or **▼** to scroll to **CLEAR EVENT LOG** and then press **ENTER**.
4. Press **▲** or **▼** to scroll to **YES** to accept changes and then press **ENTER**.
5. Press **ESC** twice to return to the global display.

Logging Data

When the Cadex analyzer is connected to a computer, you can create data logs that can be used for detailed analysis of your battery services. The log displays the data as text strings on the computer screen. Each text string appears on a line by itself. For an example of data logged with Microsoft's HyperTerminal program (see **Figure 9**, page 96).

Note If you are using the Cadex analyzer with Cadex BatteryShop™, the software's Data Monitor function is similar to the Data Log. A more powerful and flexible alternative to both the Data Log and Data Monitor, is Cadex's BatteryShop™ Real-time data-collection functionality.

Two types of text strings are created when you log data. The first is the "event string", which is generated whenever a specific event occurs. Some examples of specific events that would generate this type of data string are the start or end of a specific phase in a program; a battery or adapter insertion or removal and errors and warnings. The second, and most common event string is the "processing string", which updates battery data once a minute and indicates normal battery processing.

Text strings have seven or eight fields, which are separated by commas. The first six fields in both types of text strings are identical and represent these data elements:

- **Analyzer number.** This number is always "0".
- **Station number.** This is the number of the battery station that reported the data string.
- **Battery ID.** This field displays the battery ID, if it was entered in the Cadex analyzer. The Battery ID field always has 10 characters but some or all of them may be blank spaces.
- **Date.** This is the date the data string was created, in the format mm/dd/yyyy. This string reflects the Cadex analyzer date settings, not those of the computer.

- **Time.** This is the time the data string was created, using the 24-hour clock and in the format h:mm:ss. This string reflects the Cadex analyzer time settings, not those of the computer.
- **Event Code.** This number indicates which event has been reported. Processing strings always display event code 250, which indicates normal processing. Event strings can display any event code other than 250. For a list and explanation of event codes, see *Messages and Warnings*, page 132.

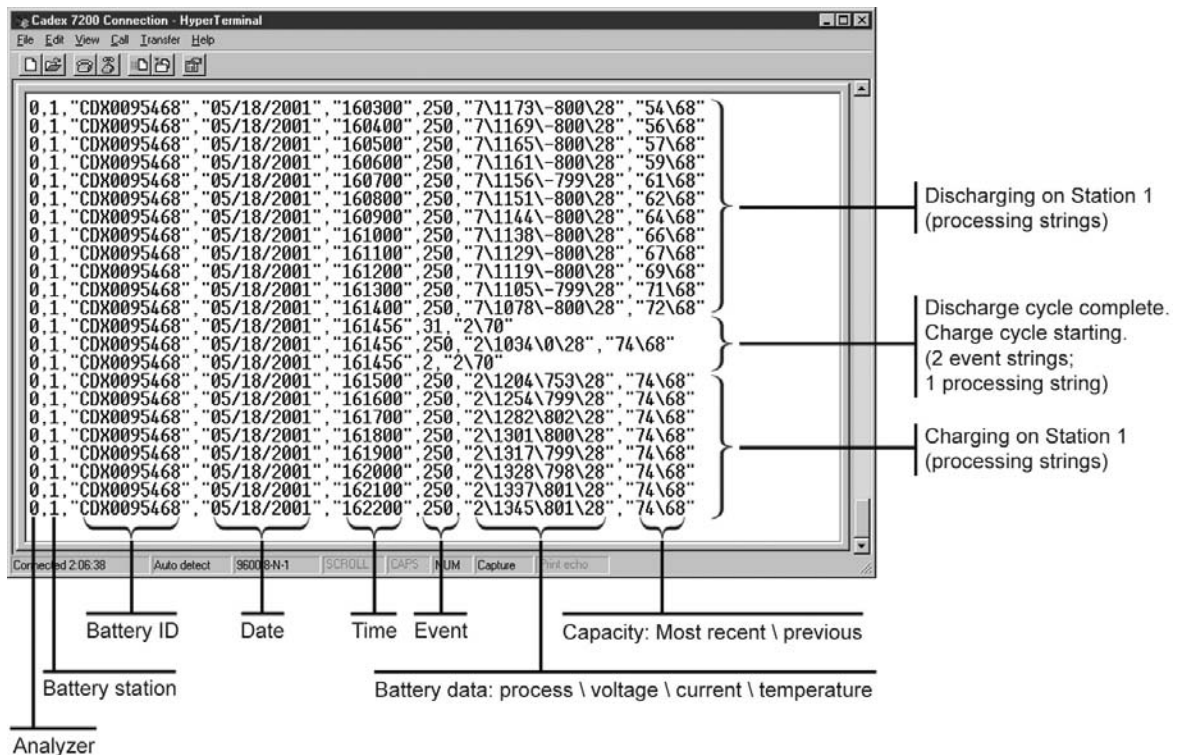

Figure 9: Sample data logged to HyperTerminal.

The content of the final part of the strings depends on the string type. Processing strings (Code 250) contain two additional fields:

- **Battery data.** This field displays four different data elements, in this order:
 - **Process or status.** This number represents the process or status of the current program as listed in *Appendix A, Messages and Warnings* (see *By Code*).

- **Voltage.** This is the terminal voltage of the battery in mV.
- **Current.** This is the charge or discharge current being applied to the battery in mA. If the current number is positive, the battery is being charged; if it is negative, the battery is being discharged.
- **Battery temperature.** This is battery temperature in degrees Celsius. If temperature sensing is disabled in the C-code, this value is always 0.

Back-slash characters separate the four elements.

- **Battery capacity.** In most cases, this field displays the current (or most recent) battery capacity and the previous battery capacity, both as percentages of the nominal battery capacity in the C-code. A back-slash character separates the two capacities. Current battery capacity is updated (increased) during discharge cycles.

Note If you were running QuickTest, this field displays the battery SoH (State of Health) as a percentage, followed by the ASCII value of the confidence grade for the matrix (A = 65, B = 66, C = 67). For more information about confidence grades, see **QuickTest™**, page 25.

The bottom text string in **Figure 9** is a processing string. It indicates that the battery in station 1 (ID CDX0095468) is processing normally (event 250), charging (process 2) with a terminal voltage of 1345mV, a charge current of 801mA, and a battery temperature of 28°C. The most recent battery capacity achieved was 74%; the previous capacity was 68%.

Event strings contain one or two fields in addition to the first six:

- **Program and target capacity.** This field displays a one- or two-digit number representing the current program and the target capacity from the C-code. A back-slash character separates the two elements.

Program codes are as follows:

0 = Auto	8 = RunTime
1 = Charge	9 = Self-Discharge

2 = Prime	10 = LifeCycle
3 = Custom1	11 = Discharge Only
4 = Custom2	12 = Extended Prime
5 = Custom3	13 = Boost
6 = Custom4	14 = QuickTest
7 = OhmTest	15 = Q-Learn
	16 = Learn

- **Battery data.** In certain cases, event strings also contain a battery data field. For example, when an automatic OhmTest is run as part of a program, the event string generated includes the OhmTest results in mΩ.

Sample text strings

Here are some sample data logging text strings followed by explanations.

```
0,2,"", "01/24/2001", "085120", 201, "0\80"
```

A battery adapter was inserted (Code 201) in station 2 on January 24, 2001 at 8:51 a.m. The current C-code specifies the Auto program with a target capacity of 80% (0\80 in the final field). Battery ID is not yet available.

```
0,2,"", "01/24/2001", "085121", 20, "0\80"
```

A battery was inserted in the adapter (Code 20).

```
0,2,"CDX01", "01/24/2001", "085140", 11, "0\80"
```

Processing of the current program began (Code 11). The battery ID is CDX01.

```
0,2,"CDX01", "01/24/2001", "085140", 250, "2\1416\398\21", ""
```

Normal processing (Code 250) of battery CDX01. The battery is charging (process = 2), terminal voltage is 1416mV, charge current is 398mA, and battery temperature is 21°C. Battery capacity has not yet been determined.

0,2,"CDX01","01/24/2001","085456",27,"0\80",341

An OhmTest was performed (Code 27). Resistance is measured at 341mΩ.

0,2,"CDX01","01/24/2001","100200",250,"7\1419\401\35","85\37"

Normal processing (Code 250). The battery is discharging (process = 7), terminal voltage is 1419 mV, discharge current is 401mA, and battery temperature is 35°C. Current battery capacity is 85%; previous capacity was 37%.

0,2,"CDX01","01/25/2001","090500",250,"5\1694\7\28","89\87"

Normal processing (Code 250). The battery is ready (process = 5), terminal voltage is 1694 mV, charge current is 7mA (trickle charge), and battery temperature is 28°C. Final battery capacity achieved is 89%; previous capacity was 87%.

0,2,"CDX090","04/11/2001","151600",250,"35\3943\0\23","76\67"

Normal processing (Code 250) of battery ID CDX090. A QuickTest has been completed (status code 35). Terminal voltage is 3943mV, no current is being applied, and battery temperature is 23° C. The battery SoH is 76% with a confidence grade of 67, the ASCII code for "C". ("A" is 65, and "B" is 66).

Setting up the Data Log

To log data to your computer, you must connect the Cadex analyzer to the serial port of your computer (see **Connecting to BatteryShop™ or a Printer**, page 70), set the Cadex analyzer to log data, and set up a program to read the data from the serial port. The procedure outlined here assumes you are using Microsoft's HyperTerminal communications program, which comes with most versions of Microsoft Windows; however, you can use any compatible communications program that can read data through the computer serial port(s).

To set the Cadex analyzer to log data to a computer

1. From the global display, press **MENU**.

2. Press ▲ or ▼ to scroll to SYSTEM SETUP and then press ENTER.
3. Press ▲ or ▼ to scroll to SERIAL PORT DEVICE and then press ENTER.
4. Press ▲ or ▼ to scroll to TERMINAL and then press ENTER.
5. Press ▲ or ▼ to scroll to YES to accept changes and press ENTER.
6. Press ▼ to scroll to SERIAL PORT SETTINGS and then press ENTER.
7. Pressing ► or ◀ to move the cursor between options and ▲ or ▼ to scroll through available settings, enter these serial port settings:
 - BAUD RATE: 9600
 - HANDSHAKE: NONE
 - DATA BITS: 8
 - STOP BITS: 1
 - PARITY: NONE
8. Press ENTER.
9. Press ▲ or ▼ to scroll to YES to accept changes and press ENTER.
10. Press ESC twice to return to the global display.

To set HyperTerminal to read Cadex analyzer data

1. Click **Start** on the Windows Task Bar, point to **Programs**, then point to **Accessories**, and then click **HyperTerminal**.
2. Double-click the **HyperTrm** or **HyperTrm.exe** icon.
3. Type a name for your data log connection, such as Cadex analyzer connection, and then click **OK**.
4. In the dialog box that appears, enter these settings:

- **Connect using.** From the list, select **Direct to Comx**, where x is the number of the serial port to which your Cadex analyzer is connected.
- **Bits per second:** 9600
- **Data Bits:** 8
- **Parity:** None
- **Stop Bits:** 1
- **Flow Control:** None

5. Click **OK**.

The HyperTerminal screen appears. The bottom left-hand corner of the screen should display the message "Connected h:mm:ss".

6. Check that HyperTerminal is communicating with the Cadex analyzer by inserting an adapter in any station on the analyzer. A text string similar to this one should appear on-screen:

```
0, 2, "          ", "01/25/2001", "095126", 201, "0\80"
```

If nothing appears on-screen, check the HyperTerminal properties:

- a) Click **File**, and then click **Properties**.
- b) Verify that the serial communication port number is correct.
- c) Click **Configure**, and verify that the serial port settings match the Cadex analyzer serial port settings.

If the Properties settings are correct, check the serial cable and connections, and verify the serial port settings on your computer and your battery analyzer.

Using the Data Log

Once you have set up a connection file, you can use that file to open HyperTerminal and log Cadex analyzer data. You can also save Cadex analyzer

data logs by capturing them as text files, which you can import into a spreadsheet program such as Microsoft Excel for graphing and analysis.

To log and save data to a text file

1. Click **Start** on the Windows Task Bar, point to **Programs**, then point to **Accessories**, and then click **HyperTerminal**.
2. Double-click **Cadex analyzer Connection** (or the name you gave the connection when you first set it up).

HyperTerminal opens and starts displaying data sent from the **Cadex analyzer**.

3. Click **Transfer**, and then click **Capture Text**.
4. Type a name for your data log text file, giving it a .txt extension.

To change the file location, click **Browse** and specify a different folder.

5. Click **Start**.

Data starts to be saved from the highlighted point on-screen.

6. When all the data you want to include in your file has been captured, click **Transfer**, then point to **Capture Text**, and then click **Stop**.

The text file is created. You can now import it into a spreadsheet program for further analysis.

To open the data log in Microsoft Excel

1. Start Microsoft Excel.
2. Click **File**, and then click **Open**.

3. In the dialog box that appears, navigate to the folder in which you saved your data log text file.
4. In **Files of Type**, select **Text Files (*.prn; *.txt; *.csv)**.
5. Click the name of the text file you want to open in Microsoft Excel.
6. Click **Open**.

You can now use Microsoft Excel functions to analyze, graph, or create a report of the **Cadex analyzer** BatteryShop data.

Note You are not limited to spreadsheet programs. Depending on what you want to do with the data, you can open your data log in any software program that recognizes comma-separated-values files. This may include word processing programs and database programs, among others.

Chapter 10 Custom Programs



These features are recommended for advanced users only.

Creating a custom program requires a good understanding of rechargeable batteries and the analyzer. Applying routines that conflict with the battery manufacturer's specifications or recommendations can damage a battery.

If you regularly modify custom programs, the use of Cadex BatteryShop™ is strongly recommended. The graphical user interface of Cadex BatteryShop™ allows easy programming and monitoring of battery performance. See Cadex's BatteryShop™ online Help for detailed instructions.

Custom programs can run virtually any sequence of service cycles. They are stored in the analyzer to be globally used by any adapter.

A custom program consists of phases 1 through 5, followed by phase DONE.

Each of the first five phases consists of two cycles, a test, and the TRUE and FALSE statements, as shown in the flow chart in

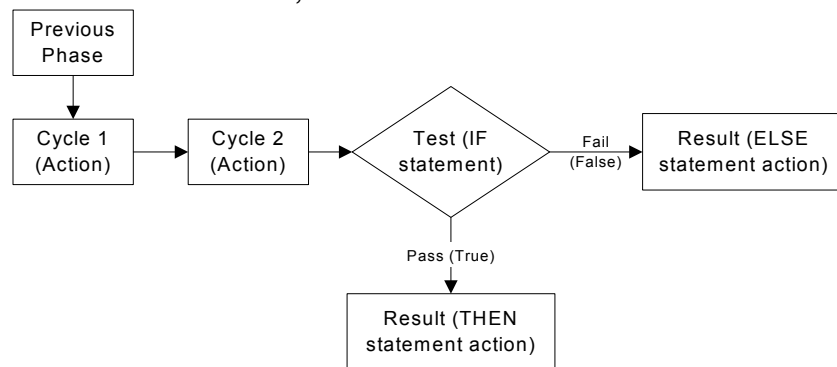

- Figure 10.

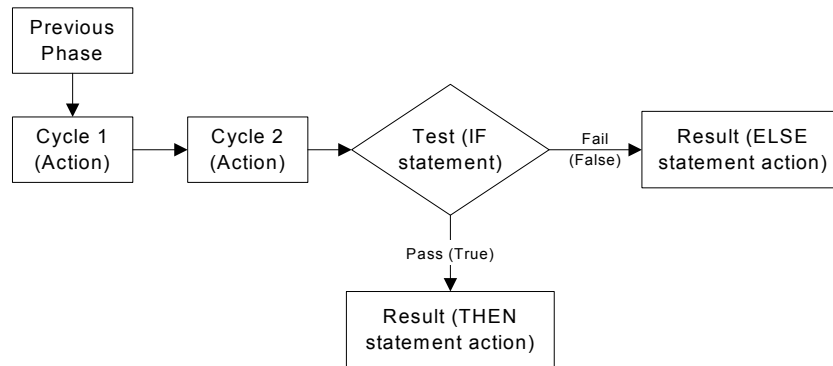

Figure 10: Custom program process, phases 1 through 5

- Phase Done consists of Cycle 1 only and does not proceed to any other cycle.

The analyzer goes through the first phase, then follows the paths prescribed by the IF, THEN, and ELSE statements in the test cycle of each phase.

Cycle 1 and Cycle 2

There are seven different actions that can be performed as Cycle 1 or Cycle 2 of phases 1 through 5.

Action	Description
Skip Cycle	Skips the cycle and goes to the next cycle or the TEST statement.
Discharge Time (for 000:00:00 at 100%)	<p>Discharges the battery for the specified time period (hhh:mm:ss)* at the discharge rate set in the extended C-code.</p> <p>A setting of 50% gives a discharge current that is 50% of the C-code discharge rate (see Discharge Rate (C-rate), page 48).</p>

Action	Description
Charge Time (for 00:00:00 at 100%)	Charges the battery for the specified time period (in hhh:mm:ss format)* at the charge rate set in the extended C-code.
Recondition Time (for 000:00:00)	Reconditions (deep discharges) the battery for the specified time period (hhh:mm:ss)* at the recondition discharge rate set in the extended C-code. This cycle is skipped for SLA and Li batteries because these chemistries cannot be reconditioned. This cycle can be applied only after a discharge cycle.
Trickle-Charge Time (rest for 000:00:00)	Charges NiCd and NiMH batteries for the specified time period (hhh:mm:ss)* at the trickle-charge rate set in the extended C-code. This cycle is skipped for SLA and Li batteries.
Rest Time (rest for 000:00:00)	Applies no current for the specified time period (hhh:mm:ss)*. The time must be specified or the cycle is skipped.
OhmTest	Performs the OhmTest on the battery.

Test

The test cycle has three parts:

- The **IF statement**, which describes a condition that must be either true or false for the battery being tested.
- The **THEN statement**, which describes the action to be taken if the battery passes the test (the condition is true).
- The **ELSE statement**, which describes the action to be taken if the battery fails the test (the condition is false).

* If the default time period of 000:00:00 is used, the analyzer services the battery according to end-of-charge, end-of-discharge or end-of-recondition settings in the extended C-code. The maximum allowable is 200:59:59.

IF Statements

You can choose from ten different test conditions, or IF statements, when you are setting tests for phases 1 through 5.

IF Statement	Description
Skip Test	Selects the TRUE statement. The FALSE statement is ignored.
IF Target Capacity Met	Selects the TRUE statement if the capacity during the last discharge cycle meets the target capacity; otherwise, selects the FALSE statement.
IF Target Capacity Not Met	Selects the TRUE statement if the capacity during the last discharge is below the target capacity; otherwise, selects the FALSE statement.
IF < 5% Capacity Increase	Selects the TRUE statement if the improvement in capacity during the last two discharge cycles is less than 5% (for example, the last one is 88% and the one before is 85%); otherwise (for example, if the last one is 90% and the one before is 80%), selects the FALSE statement.
IF > 5% Capacity Increase	Selects the TRUE statement if the improvement in capacity during the last two discharge cycles is more than 5% (for example, the last one is 90% and the one before is 80%); otherwise (for example, 88% and 85%) selects the FALSE statement.
IF Total Capacity < 5%	Selects the TRUE statement if the capacity during the last discharge cycle is less than 5%; otherwise, selects the FALSE statement.
IF Total Capacity > 5%	Selects the TRUE statement if the capacity during the last discharge cycle is greater than 5%; otherwise, selects the FALSE statement.
IF User Defined Timeout	Selects the TRUE statement if the time period set in Cycle 1 or Cycle 2 expires before the battery is fully charged, discharged or reconditioned; otherwise, selects the FALSE statement. For Trickle Charge and Rest, the program selects the TRUE statement only.

IF Statement	Description
IF Loop Count < Max	Selects the TRUE statement if the number of cycles (the loop count) is less than the value set in THEN REPEAT X TIMES of the TRUE statement or ELSE REPEAT X TIMES in the FALSE statement; otherwise, selects the FALSE statement.
IF Loop Count > Max	Selects the TRUE statement if the number of cycles (the loop count) is more than the value set in THEN REPEAT X TIMES of the TRUE statement or ELSE REPEAT X TIMES in the FALSE statement; otherwise, selects the FALSE statement.

THEN and ELSE Statements

There are ten possible responses to the results of the IF statement. Each of these responses is available as a THEN statement (for when a battery meets the condition, or passes) or as an ELSE statement (for when a battery does not meet the condition, or fails).

THEN/ELSE Statement	Description
Starts the next phase.	Starts the next phase.
Go to Phase 1	Starts Phase 1.
Go to Phase 2	Starts Phase 2.
Go to Phase 3	Starts Phase 3.
Go to Phase 4	Starts Phase 4.
Go to Phase 5	Starts Phase 5.
Go to Done	Starts Phase Done.
REPEAT 0 times	Repeats actions in the current phase the number of times specified. Available settings: <ul style="list-style-type: none"> • 1 to 8 • FOREVER. The program continues forever. See the “IF Loop Count<Max” and “IF Loop Count>Max” statements, above.

THEN/ELSE Statement	Description
REST for 000:00:00	Applies no current for the specified time period (in hhh:mm:ss format). The RESTING message (code 19) is displayed with time counting down. After resting, the program goes to the next phase.
FAIL	Fails the battery. The battery is electrically disconnected, the FAIL light comes on, and the WARNING message (code 16) appears.

Phase Done

You can perform one of three different actions in the final phase of the custom program.

Action	Description
Ready—No Charge	Ends the program. The green READY light is on, and no trickle charge is applied.
Ready—Trickle Charge	Trickle-charge the battery using the trickle-charge rate in the extended C-code. Includes the standby maintenance cycle, which performs a discharge/charge every 30 days (180 days for SLA).
Trickle Charge	Trickle-charge the battery using the trickle-charge rate in the extended C-code.

Creating and Editing Custom Programs

To create or edit a custom program

1. From the global display, press **MENU**.
2. Press **▲** or **▼** to scroll to PROGRAM SETTINGS and then press **ENTER**.
3. Press **▲** or **▼** to scroll to CUSTOM PROGRAMS and then press **ENTER**.
4. Press **▲** or **▼** to scroll to the program you want to create or edit, for example, CUSTOM 1.

5. Press **EDIT**. The cursor appears on Phase 1.
6. Press **▶** to move the cursor to the Cycle 1 field.
7. Program the action to be completed during this cycle:
 - a) Press **▲** or **▼** to select the action.
 - b) Press **▶**.
 - c) If necessary, use the direction keys or the number pad to enter any additional settings required for the cycle and then press **▶**.
8. Repeat step 7 for Cycle 2 of the phase.
9. Program the test for the phase:
 - a) Press **▲** or **▼** to select the IF statement, the test to be performed. (see **Test**, page 106).
 - b) Press **▶**.
 - c) Press **▲** or **▼** to select the THEN, or TRUE, statement (the action to be performed if the battery passes the test). Available THEN and ELSE statements are described on page 108.
 - d) Press **▶**.
 - e) Press **▲** or **▼** to select the ELSE, or FALSE, statement (the action to be performed if the battery fails the test).
 - f) Press **▶**.
10. Press **▲** to move to the next phase.
11. Repeat steps 6 – 10 for phases 2 – 5.

Once Phases 1 through 5 have been programmed, the cursor appears on Phase Done.

12. Program the action for Phase Done:
 - a) Press **▶** to move to Cycle 1.
 - b) Press **▲** or **▼** to select the action to be performed. (There is only one cycle for Phase Done.)
13. When you have finished entering the settings, press **ENTER**.
14. Enter a name for the program, if desired:
 - Press **▲** or **▼** to scroll through upper case letters, lower case letters, punctuation marks, numbers, and a space (which looks like an underscore) to select characters for the program name.
 - Press **▶** or **◀** to move the cursor between character positions within the program name. There are seven positions available.
15. Press **ENTER**.
16. Press **▲** or **▼** to scroll to **YES** to accept changes and press **ENTER**.
17. Press **ESC** twice to return to the global display.

Sample Custom Program

NiCd or NiMH batteries that do not meet the target capacity should always be reconditioned. If the battery does not meet the target capacity after reconditioning, the program fails the battery.

Phase	Action
Phase 1	Charge the battery.
Phase 2	Discharge to find the battery capacity. If the capacity meets the target capacity, complete the program (Phase Done). If the target capacity is not met, apply the recondition cycle (Phase 3).
Phase 3	Recondition and charge the battery.
Phase 4	Discharge to find capacity after the recondition cycle. If the capacity meets the target capacity, charge the battery (Phase 5). If the target

capacity is not met, fail the battery.

Phase 5 Fully charge the battery.

Phase Done Complete the program with a trickle charge to maintain capacity.

The flowchart in Figure 11 on the next page demonstrates how this program works.

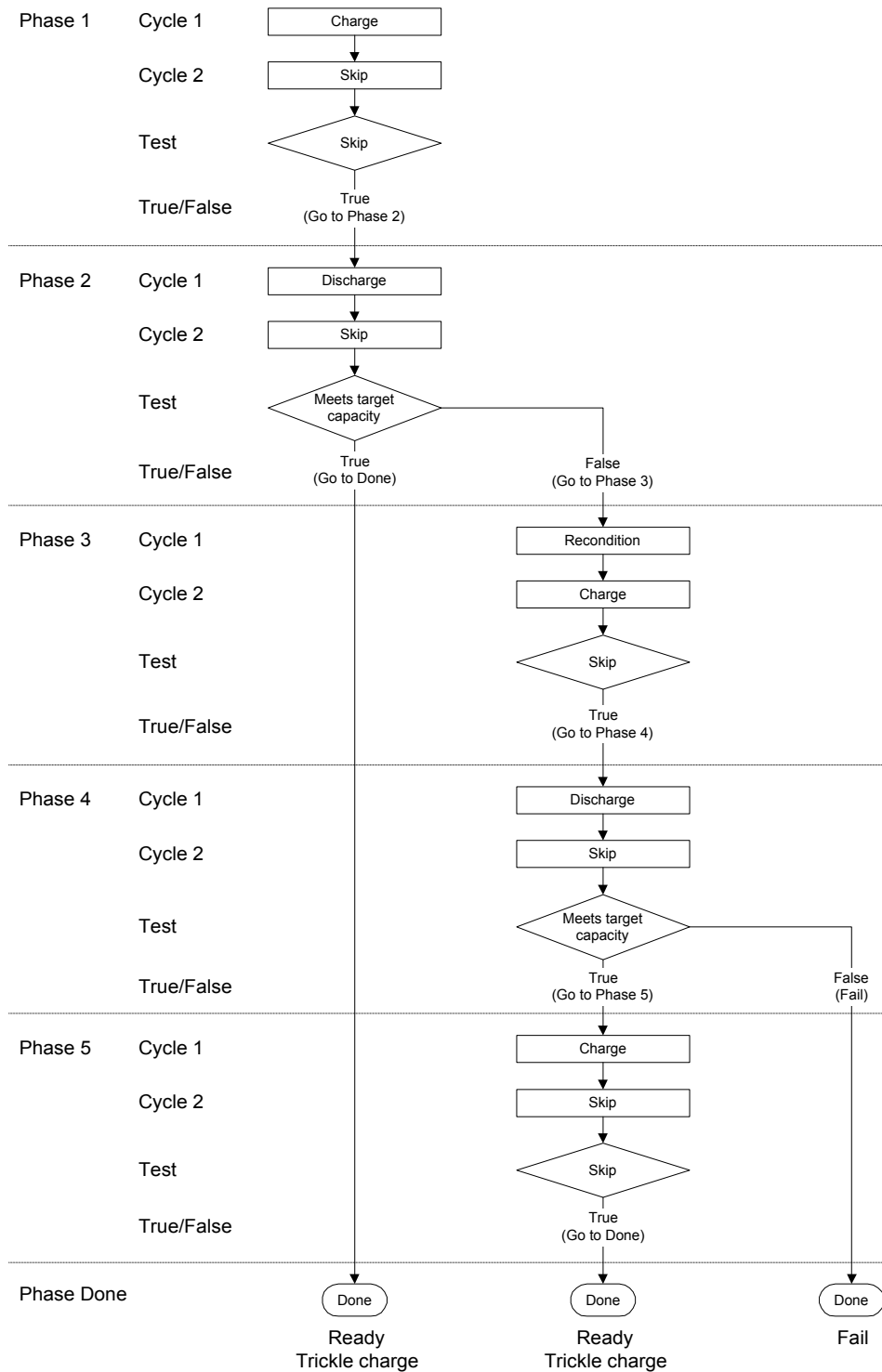

Figure 11: Flow chart for sample custom program

Chapter 11 **Services and Upgrades**



Caution!

There are no internal user-serviceable parts in the Cadex analyzer other than the internal backup battery.

Except for changing the battery, unauthorized disassembly and/or repair of the analyzer by other than an authorized Cadex Service Center will void the warranty.

See Appendix D - ***Parts and Accessories***, page 162 for information about ordering replacement parts.

Replacing the Primary (Input) Fuse

If the analyzer does not power up but the input line is okay and power cord is firmly inserted, the primary (input) fuse may need to be replaced (see Appendix D - ***Parts and Accessories***, page 162).

To replace the primary fuse

1. Remove all batteries and adapters, turn off the analyzer and unplug the power cord. Wait one minute before continuing.
2. Locate the fuse holder below the power cord socket.
3. Open the fuse cover by turning it counterclockwise with a small coin or screwdriver.

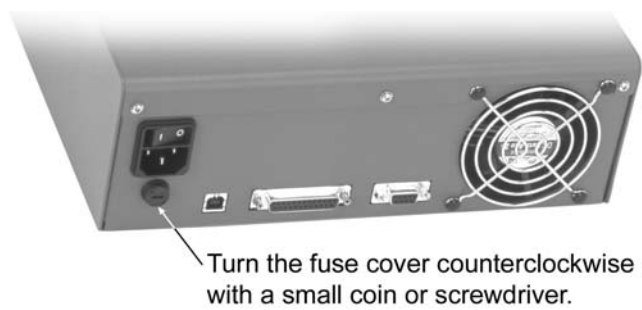

Figure 12: Replacing the fuse

4. Remove and examine the fuse carefully.

If the filament inside the glass tube is broken, replace the fuse. Be aware that the filament can sometimes appear intact even when it is broken.

5. Close the fuse cover by pushing and turning it clockwise with a small coin or screwdriver until it locks in place.
6. Insert the power cord and turn on the analyzer.

Replacing the Backup Battery

The C7000 Series Battery Analyzer uses a 3-volt lithium coin battery (type CR2032 or equivalent) to save settings while the analyzer is turned off. With ordinary use of the C7000 Series Battery Analyzer, you should have to replace the battery only every seven to ten years.

You need the following:

- A small Phillips screwdriver.
- A new 3-volt lithium battery.
- A wrist strap or other device to eliminate electrostatic discharge.



ELECTROSTATIC SENSITIVE DEVICE!

Do not open the C7000 Series Battery Analyzer Battery or touch any part of its internal components if you are not grounded.

To replace the Cadex analyzer backup battery

1. Remove all batteries and adapters, turn off the analyzer and unplug the power cord and serial and parallel port cords. Wait one minute before continuing.



Do not attempt to open the C7000 Series Battery Analyzer while it is plugged into an electrical outlet or any peripheral device.

Severe electrical shock and/or damage to the analyzer could result!

2. Use the Phillips screwdriver to remove the three screws along the top of the back panel.



Figure 13: C7400 and C7400ER: Remove the back screws

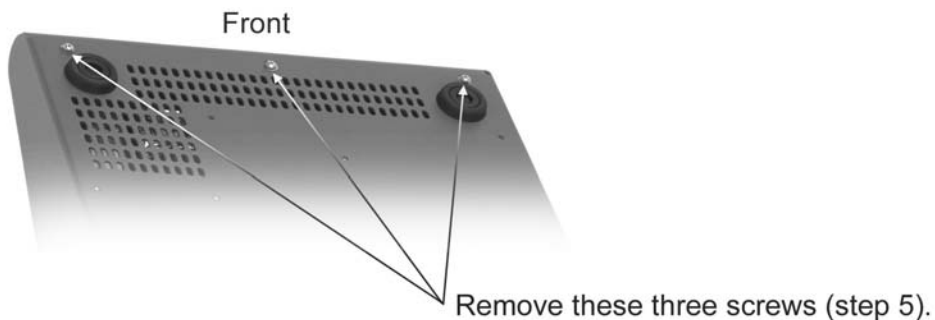

Figure 14: C7200: Remove the bottom screws

3. Remove the top cover by sliding it back slightly and then lifting.

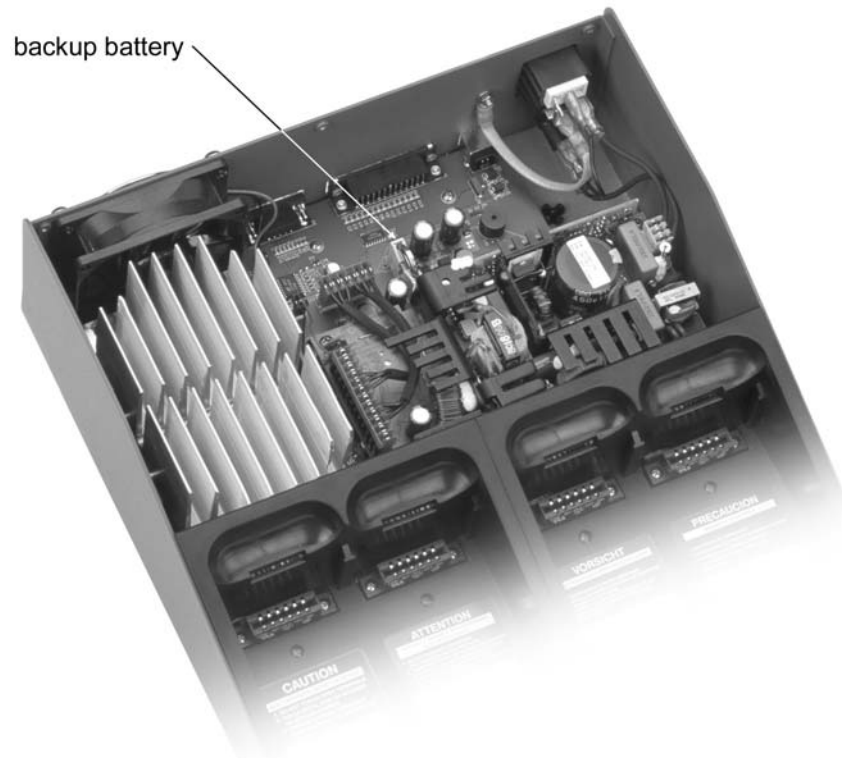

Figure 15: Cadex 7400 with cover removed. The backup battery on the C7400ER is in a similar location

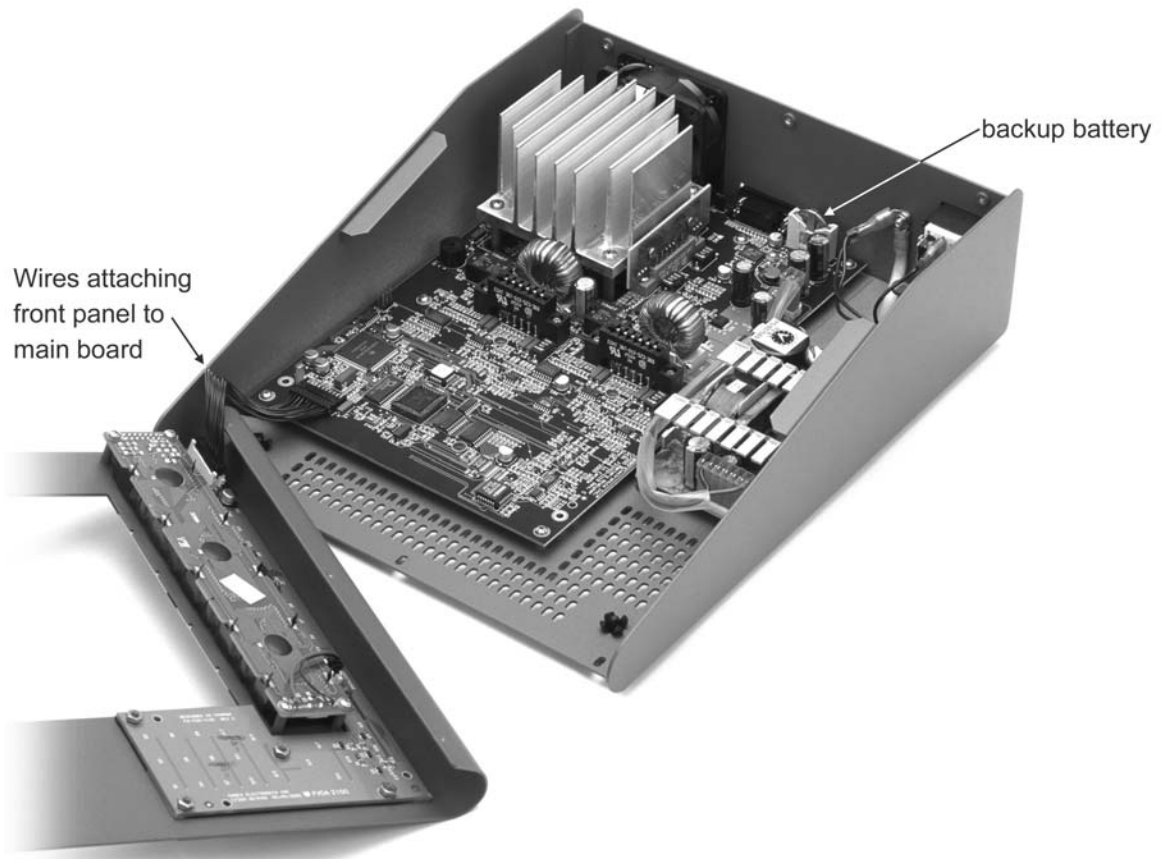

Figure 16: Cadex C7200 with cover removed

4. The battery is located towards the back of the analyzer (see Figure 15). Carefully remove the existing battery:
 - a) Move the upper clip of the battery holder out of the way.
 - b) Using your fingers or insulated pliers or tweezers, *gently* pull the old battery out of the holder. Be very careful not to damage the battery.



Caution!

Do not use pliers or tweezers with bare metal tips. They will short the battery.

5. Insert the new battery in the holder, with the positive terminal facing into the clip and away from the fan until the clip slips in place.
6. Replace the cover and the three screws on the back panel. Ensure that no interior wires or cables are caught or pinched between the cover and the unit.
7. Plug in the power cord and serial cable.
8. Turn on the machine. All settings, including custom programs, will have returned to factory defaults, so you will have to reprogram any customized settings or programs.

Replacing the Station Fuses

Each station on the C7000 Series Battery Analyzer has a protection fuse (marked F1 to F4) located beside the adapter socket on the main board.



DO NOT ATTEMPT TO REPLACE THESE FUSES BY YOURSELF. ONLY A CADEX SERVICE CENTER IS AUTHORIZED TO REPLACE THESE FUSES.

Station Fuse

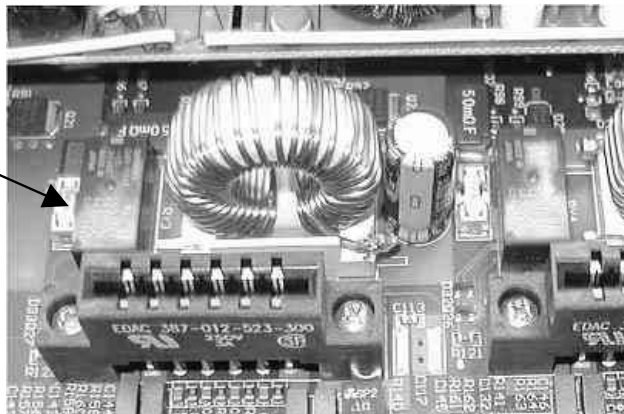

Upgrading the Firmware

From time to time, Cadex offers firmware upgrades for the **Cadex analyzer**. These can usually be downloaded to your computer from our Internet site (www.cadex.com) and then copied to your **Cadex analyzer** using the Cadex Firmware Utility software, available from Cadex Electronics Inc. (the Firmware Utility software comes with BatteryShop™).

The current version of the firmware is always displayed in the lower left-hand corner of the **Cadex analyzer** startup screen, followed by the current version of the Cadex Firmware Utility software, as shown here:

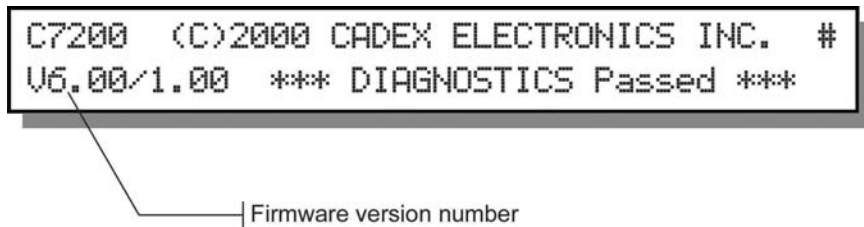

You can also display this screen without restarting the unit.

To verify firmware version (display start-up screen)

1. From the global display, press **FN** and then press **7**.
2. Press **ESC** to return to the global display.

Resetting the System

You can reset the system to the factory defaults.

The parameters that are reset to their default values include these settings:

- OhmTest, Runtime, Self-Discharge, Life-Cycle and custom programs.
- Battery startup settings.
- Key sound and alert sound.
- Parallel port device.

- Voltage display.
- Service counter (number of batteries serviced).

The setting for the serial port device changes to BATTERYSHOP.

To reset parameters to the factory default and restart the analyzer

1. From the global display, press **ALT**, and then press **0**.
2. Press **ENTER** to confirm or **ESC** to cancel.

Note This function also serves as a general system reboot.

Cleaning the Analyzer



Caution! Before cleaning, turn off the power and unplug the AC power cord.

Clean the analyzer only with a damp cloth moistened with mild soap and water and allow to thoroughly dry. **Do not allow any liquids to enter the analyzer case under any circumstances.**

Chapter 12 **System Calibration**

There are two kinds of calibration that should be performed on the Cadex analyzer on a regular basis: voltage calibration; and adapter, or station, calibration.

Calibrating Voltage

Voltage calibration should be performed at least yearly. To calibrate the voltage, you need a calibration kit, which consists of calibration adapters and an instruction sheet (see Appendix D - **Parts and Accessories**, page 162) for ordering and part-number information.

To calibrate the voltage

1. Remove all battery adapters.
2. From the global display, press **MENU**.
3. Press **▲** or **▼** to scroll to **SYSTEM SETUP** and then press **ENTER**.
4. Press **▲** or **▼** to scroll to **CALIBRATE VOLTAGE** and then press **ENTER**.
5. Firmly insert the two voltage calibration adapters, one into each station.
6. Wait for the prompt, then remove the calibration adapters.
7. Press **MENU** to return to the global display.

8. Press **FN**, and then press **7**. The “#” sign appears in the upper right corner of the startup screen, indicating successful completion of voltage calibration.

Servicing the Voltage Calibration Adapters

Return the voltage calibration adapters to the factory every three years for authorized calibration. Contact Cadex for a Return Authorization number.

Calibrating Adapters

Battery adapters should be calibrated once a year or whenever they are moved from one analyzer to another. Station calibration corrects variations in tolerances due to aging of the components in the adapter and compensates for voltage loss from cables and electrical contacts.

Failure to calibrate battery adapters can cause inaccurate capacity readings, especially on low voltage batteries or single cells operating at high charge or discharge currents. OhmTest and QuickTest™ results can also be affected, in some cases dramatically.

Use an electrical short with a 10 AWG wire or a copper plate for this procedure.

To calibrate an adapter

1. Make sure that there is no battery inserted into the adapter.
2. From the global display, press **FN** and then press **8**.

Or

- a) From the global display, press **MENU**.
- b) Press **▲** or **▼** to scroll to **SYSTEM SETUP** and then press **ENTER**.
- c) Press **▲** or **▼** to scroll to **CALIBRATE STATION** and then press **ENTER**.

3. Press the station key for the station that contains the adapter you want to calibrate.

Use a short length of heavy gauge wire (AWG 10) or a copper plate to short the positive and negative terminals on the battery adapter together. If you are calibrating a Smart Cable Adapter, clip the leads together.



Do NOT short the temperature sensor on the adapter.

Do NOT short the contacts on a battery.

4. Press **ENTER** to start calibrating. Calibration takes about 20 seconds.
5. Remove the adapter when prompted.

Adapter Calibration Values

Adapters are calibrated at the factory and the calibration value is permanently stored in adapter memory. After calibration, the new calibration value and factory calibration value are compared.

If the difference between the calibration values is less than 50mΩ, the new value is displayed on the screen and replaces the factory calibration value.

If the difference is more than 50mΩ, the calibration value and the original factory calibration value is displayed; select Yes or No to accept or discard the new value.

If the new calibration is over 400mΩ, the new value is rejected.

Use an electrical short with a 10 AWG wire or a copper plate when calibrating to keep calibration values within 50mΩ.

Calibration Values for QuickTest™

If you are planning to use QuickTest™, check the calibration result with the following table. These values cannot be used to determine if an adapter is faulty or not. It only indicates if the adapter has an acceptable range for QuickTest™.

These ranges are only for new adapters. Older adapters may have higher values.

All values were determined using a 1" wide copper plate for shorting. For the blade contacts, the values were collected using a 10AWG wire with banana plugs.

Contact Type	Typical Calibration Resistance
Flat blade shaped contacts (typical for laptop battery adapters)	C7200 & C7400 < 220mΩ C7400ER < 250mΩ
All other contacts (including removable Pogo contacts)	C7200, C7400 and C7400ER < 250mΩ
Smart Cable (07-110-0115)	C7400 < 270mΩ C7400ER < 330mΩ
Flex Arm (07-110-0180)	C7200, C7400 and C7400ER < 380mΩ

Note: The Smart Cable (07-110-0115) and FlexArm (P/N 07-110-0180) are not recommended for QuickTest™

Chapter 13 Solving Problems and Getting Help

Troubleshooting

The common problems and solutions listed below will answer most of your questions. The detailed alphabetical list of display messages in Appendix A - **Messages and Warnings** on page 132 can help to sort out problems not listed here.

If you need personalized help, contact the Technical Support department at 1 800 565-5228.

Problem	Possible Reasons or Solutions
Analyzer does not power up.	Make sure that the power cord is firmly inserted in the back connector. Check the power supply Check the input fuse, (see Replacing the Primary (Input) Fuse , page 114).
Analyzer prompts for the Battery ID	Turn OFF the 'Ask for Battery ID' setting in Battery Startup under the Option Controls, (see To set user input , page 78).
Battery continually cycles without ending on QuickTest	Battery Cells may be soft or in poor condition. Verify battery condition using the Auto program. Battery may be unable to be QuickTest™.

Problem	Possible Reasons or Solutions
Battery disconnected during service and is not recognized by the analyzer	<p>If the battery is hot, the thermal fuse may have temporarily opened the battery. Lower the charge rate and allow the battery to cool before servicing again.</p> <p>Protection circuits in the battery may not be able to handle the rapid pulses of the OhmTest. Turn off the automatic OhmTest, (see To turn Automatic OhmTest on or off, page 79)</p>
<p>Battery has completed service but there is no LED</p> <p>Battery is getting hot</p>	<p>Contact Cadex for a firmware upgrade.</p> <p>It is normal for batteries to heat up during charge. However, they should be just warm to the touch. If they are getting too hot, reduce the Charge rate or Trickle Charge Rate in the Extended C-code and/or activate the adapter temperature sensing.</p>
Battery passes on analyzer but fails in the field.	<p>Run OhmTest. If the resistance is high, the battery may not be able to hold a charge.</p> <p>Run Self-Discharge. If self-discharge is more than 30%, the battery may not be able to hold a charge.</p>
Battery service does not start or is not recognized when inserted in the analyzer.	<p>Ensure that the adapter is firmly inserted into the analyzer.</p> <p>Verify that the battery is correctly and firmly inserted into the adapter. Ensure that the contacts on the battery connect with the contacts on the adapter.</p> <p>If the battery has a switch, turn it on.</p> <p>Press ENTER after selecting the C-code and the service program.</p> <p>Verify that the selected C-code is correct for the battery.</p> <p>Battery voltage is too low for battery to be recognized by the unit. Run Boost, (see To run the Boost program, page 36).</p>

Problem	Possible Reasons or Solutions
Cannot program an 18V (or higher voltage) battery.	The C7200 and C7400 can support a maximum of 14.4V. The C7200 and C7400 cannot be modified to accommodate batteries higher than 14.4V. Batteries higher than 14.4V require the C7400ER.
Capacity readings between stations are inconsistent.	Verify that the C-codes are the same between stations. Calibrate the stations, (see <i>To calibrate an adapter</i> , page 123).
Clicking noise is heard from the analyzer when batteries are being charged.	The noise is caused by pulse charges in the analyzer circuits. This noise is normal.
Code 150 appears when Li-ion batteries are serviced. Temperature Sensing in the C-code cannot be Disabled.	For Li-ion batteries, adapters must have temperature-sensing capability. A custom-designed adapter is strongly recommended.
Connection between battery and the analyzer is intermittent.	The battery may be intrinsically safe. Change the charge method in the extended C-code to DC Charge; lower the charge and discharge rates; reduce the end-of-discharge setting to 0.92 V/cell. Ensure that the adapter is correct. Verify if the battery contacts or adapter terminals are damaged.
Capacity of the analyzer is different from the older model C7000 analyzer.	Check that all the C-codes match. Calibrate the adapter. Set the 'Charge Optimization' to 'Charge', (see <i>Optimizing Charge Time or Capacity</i> , page 80)
Dates are changing or negative dates are appearing.	Replace the backup battery, (see <i>Replacing the Backup Battery</i> , page 115)
Display is frozen and there are clicking sounds	Contact Cadex.
Fan changes speed.	This is normal.
LED is flashing irregularly	Contact Cadex.
NULL CODE appears on the display	C-code is blank. Program a C-code, (see <i>Create or Edit a C-code</i> , page 59).

Problem	Possible Reasons or Solutions
Password is not accepted even though no password is stored in the analyzer.	Replace the backup battery, (see <i>Replacing the Backup Battery</i> , page 115).
Program did not resume after a power failure.	Default power-off time out is 1 hour. Users can increase the default time to 2; 12; 24; 48 or 72 hours. Note: if using BatteryShop™, servicing data will not be saved. If the power fails during the information save, the program will not continue when power resumes. Replace the backup battery, (see <i>Replacing the Backup Battery</i> , page 115).
QuickTest, Q-Learn and Learn does not appear on the display	Older battery adapters have a 4-kilobit capacity. All new battery adapters manufactured by Cadex, however, have a 16-kilobit capacity. (All 16K adapters are identified with a label at the back.) You must have 16K adapters to use the QuickTest™, Q-Learn and Learn programs.
Reports or labels are not printing.	Check the serial port setup for the serial printer (see <i>Connecting Devices to the Serial Port</i> , page 71). Check that the serial port is enabled for correct print device (see <i>Connecting Devices to the Serial Port</i> , page 71). Check that the serial cable is correctly configured (see <i>Typical Serial Cable Pin Configurations</i> , page 73).
Resistance readings are consistently high.	Calibrate the station, (see <i>Calibrating Adapters</i> , page 123). The battery or adapter contacts may be damaged. The battery is faulty.

Problem	Possible Reasons or Solutions
Service starts without asking for the C-code	Turn ON the 'Ask for Battery C-code' setting in Battery Startup under the Option Controls, (see To set user input , page 78).
Single cell gives inconsistent results.	<p>Calibrate the station, (see To calibrate an adapter, page 123).</p> <p>Set the charge method in the extended C-code to DC Charge (for low terminal voltage).</p> <p>Single cells are discharging or charging too quickly. Lower the discharge and charge rates to 0.2 C.</p>
Temperature is not displayed on the detailed station screen during service	Turn on the temperature sensing in the C-code, (see Temperature Sensing , page 50).
Analyzer does not respond to input and there is continuous beeping	Incomplete boot or power failure during in boot up. Remove the adapters, restart the analyzer.

Manual Updates and Other References

The Cadex website is an additional resource for information about Cadex products. Visit www.cadex.com For:

- Product specifications and technical information
- Articles
- FAQ
- Battery adapter catalog
- User manual and firmware version updates

For more information about rechargeable batteries, *Batteries in a Portable World* (second edition) is an authoritative and popular reference book. Written by Isidor Buchmann, Cadex President and founder, *Batteries in a Portable World* can be ordered by visiting the Cadex website or by calling Cadex Electronics Inc.

Technical Support

If you have a technical problem that cannot be solved with this manual or the Cadex Web site, contact our Technical Support department by phone, fax, e-mail, or mail. Provide the following information:

- Serial number of the analyzer and firmware version (press **FN** and then **7** to display the version number)
- Display message and/or code
- LED lights that are on or flashing
- What you were doing when the problem occurred? Exactly what happened?
- Move the adapter and/or battery between stations to isolate if it is a battery or adapter issue.

For questions related to batteries or adapters, also provide the following:

- Battery model number
- Adapter number
- C-code being used (including parameter settings)
- Display message and/or code

You can reach Cadex Technical Support by phone from 8:00 am to 4:30 pm, Pacific Time (GMT -8:00), Monday through Friday.

- Telephone: +1 604 231-7777 ext. 315
- Toll Free: +1 800 565-5228 (US and Canada only)
- Fax: +1 604 231-7755
- E-mail: service@cadex.com
- Mail: Cadex Electronics Inc.
22000 Fraserwood Way, Richmond, BC, Canada V6W 1J6
Attn: Product Support

Appendix A

Messages and Warnings

This appendix describes all the messages and warnings that can appear on the display.

The global message is the first to appear, often with the warning code number.

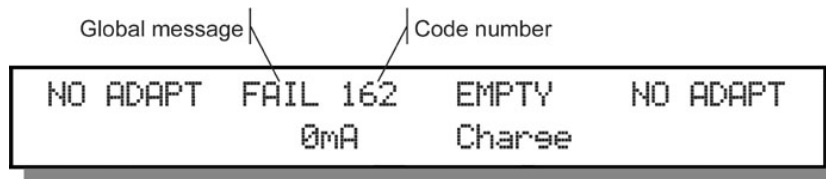

To view the detailed warning message, press the appropriate station key, in this case **2**, and then press \blacktriangledown . A display similar to this one appears:

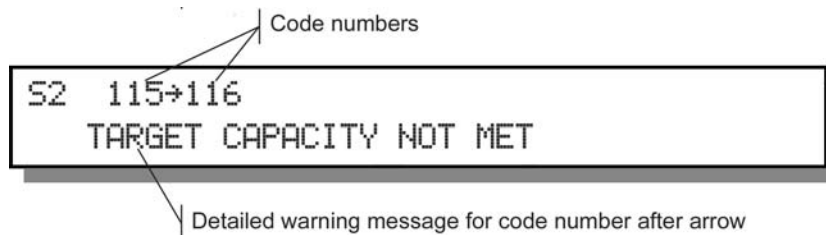

Messages and warnings are listed in this appendix by code number and by detailed message. The listing by detailed message also lists the usual reasons for the appearance of individual messages as well as possible solutions to the problems they indicate.

Non-Coded Messages

Global Message	Description
Battery Service Limit Reached	Reset the Service Counter, (see To set the battery service counter , page 69)
BatteryShop™ Mode Wait	Analyzer is waiting for input from BatteryShop™ software. If the unit is not connected to BatteryShop™, disable the Serial Port, (see Connecting to BatteryShop™ or a Printer , page 70)
Calibration Error	The short between terminals may have disconnected during calibration. Redo the calibration.
C-code Locked	C-code is locked and cannot be edited. Use an unlocked C-code. Delete and re-enter the C-code to remove the locked C-code.
Internal Error	LCD memory is full. Press the Esc key to clear the buffer and restart the analyzer. Services may resume.
N/A	Not Applicable. QuickTest™ or OhmTest has not yet been completed.
N/R	Not readable. QuickTest™ could not determine the SoH for the battery. In most cases, the resistance may not be within acceptable limits.
NULL CODE	See Code 211 (NULL C-CODE IN ADAPTER) in the next section.
Unable to Print	Printer port is disabled. Serial Port and Parallel Port may be sharing the same printer setting. Set the serial or parallel port to another device or set it to Disabled, (see Connecting to BatteryShop™ or a Printer , page 70)

By Code

In this table, messages and warnings are listed in order of code number (see **By Detailed Message**, page 137).

Code	Global Message	Detailed Message
0	OFFLINE	STATION OFF LINE
1	NO ADAPT	NO ADAPTER
2	CHARGE	CHARGING
3	TRKL CHRГ	TRICKLE CHARGE
4	RECOND.	RECONDITIONING
5	READY	READY
6	DCHG WAIT	DISCHARGE WAIT
7	DISCHARGE	DISCHARGING
8	INSERT	INSERT THE BATTERY
9	CHG WAIT	CHARGE WAIT
10	EMPTY	NO BATTERY
11	START	START BATTERY PROCESS
12	COLD WAIT	BATTERY TOO COLD
13	HOT WAIT	BATTERY TOO HOT
14	OVERHEAT	BATTERY OVER TEMP
15	FINISHED	PROCESS COMPLETE
16	WARN 16	PROGRAM HAS FAILED
17	REMOVED	BATTERY REMOVED
18	INTERRUPT	PROCESS SUSPENDED
19	RESTING	RESTING
20	INSERTED	BATTERY INSERTED
21	RESTING	RESTING
22	CAL WAIT	SETTING UP CALIBRATION
23	CALIBRATE	STATION CALIBRATING
25	RESUME	PROCESSING RESUMING
26	REMOVED	BATTERY REMOVED
27	OHMTEST	RESISTANCE TEST
28	OHMTEST	RESISTANCE TEST
29	CALIBRATE	STATION CALIBRATING
30	END CYCLE	CHARGE CYCLE COMPLETE
31	END CYCLE	DCHG CYCLE COMPLETE
32	RESUMED	CYCLE RESUMED
33	END CYCLE	USER PROGRAMMED TIMEOUT
34	BATSHOP	BATSHOP MODE WAIT
35	FINISHED	PROGRAM COMPLETE or QuickTest Completed for BatteryShop

Code	Global Message	Detailed Message
36	FINISHED	PROGRAM COMPLETE or Q-Learn completed for BatteryShop
112	ALERT 112	CELL MISMATCH
113	ALERT 113	PLATEAU TIMEOUT
115	FAIL 115	TARGET CAPACITY NOT MET in service
116	FAIL 116	TARGET CAPACITY NOT MET after service
118	ALERT 118	CHRG CURRENT REDUCED
120	FAIL 120	OVER VOLTAGE
121	REVERSED	BATTERY REVERSED
122	SHORTED	BATTERY SHORTED
123	LOW VOLT	LOW VOLTAGE TIMEOUT1
124	LOW VOLT	LOW VOLTAGE TIMEOUT2
125	LOW VOLT	NO SLOPE TIMEOUT ZONE1
126	LOW VOLT	LOW VOLTAGE AT NEG. SLOPE
127	LOW VOLT	LOW VOLTAGE TIMEOUT3
128	SOFT	UNABLE TO CLAMP CHARGE VOLTAGE
129	FAIL 129	INTERMITTENT BATTERY
130	ALERT 130	CURRENT RISE AT FULL CHARGE
135	FAIL 135	HIGH CELL RESISTANCE
136	FAIL 136	HIGH CELL RESISTANCE
142	TIMEOUT	DISCHARGE TIMEOUT
144	TIMEOUT	CHARGE TIMEOUT
146	TIMEOUT	RECONDITION TIMEOUT
150	FAIL 150	THERMISTOR FAILURE
152	TEMP RISE	RAPID HEAT RISE
154	HOT BATT	CHG COMPLETE TEMP. RISE
156	TEMP RISE	HOT BATTERY, LOW VOLTAGE
158	HOT BATT	HEAT TERMINATION
159	FAIL 159	HOT BATTERY ON TRICKLE CHARGE
160	FAIL 160	BAD FUSE OR DRIVER
162	FAIL 162	DISCHARGE CURRENT LOW
164	FAIL 164	CHARGE CURRENT LOW
170	FAIL 170	CALIBRATION FAULT
171	FAULT	SMART ADAPTER FAULT
172	FAULT	SMART BATTERY FAULT
175	LOW SOC	BATTERY UNDERCHARGED
176	HIGH SOC	BATTERY OVERCHARGED
177	ALERT 177	BATTERY UNDERCHARGED
178	ALERT178	BATTERY OVERCHARGED
179	FAIL 179	UNABLE TO LEARN MATRIX
188	INTERRUPT	SERVICE INTERRUPTED
192	READY	CELL MISMATCH CORRECTED
195	READY	CAP. IMPROVED TO TARGET

Code	Global Message	Detailed Message
200	POWER ON	POWER ON
201	ADAPT IN	ADAPTER INSERTED
202	ADAPT OUT	ADAPTER REMOVED
203	(none)	PASSWORD ENTERED
204	(none)	INVALID PASSWORD ENTERED
205	(none)	SECURITY ENABLED
206	(none)	ADAPTER SETUP UPDATED
207	SYST-TEMP	SYSTEM TEMP. HIGH: COOLING
208	FAIL 208	ADAPTER NOT SETUP
209	INV ADAPT	ADAPTER DATA INVALID
210	BAD ADAPT	BAD ADAPTER
211	NULL CODE	NULL C-CODE IN ADAPTER
250	(none)	(none – battery being processed)

By Detailed Message

Detailed Message	CODE	Reasons	Solutions
ADAPTER DATA INVALID	209	<p>Invalid value in selected C-code.</p> <p>The C-code is not compatible with the firmware.</p> <p>There may be a defect with the adapter memory</p>	<p>Delete and re-enter the C-code, reset the extended C-code to default values.</p> <p>Contact Cadex to upgrade firmware.</p>
ADAPTER INSERTED	201	Adapter is detected on a station. This message appears momentarily.	If the message persists, Press Esc.
ADAPTER NOT SET UP	208	Adapter is not programmed with a C-code, or the C-code is invalid.	Delete and re-enter the C-code. Contact Cadex to upgrade firmware.
ADAPTER REMOVED	202	Adapter is removed from a station.	If message persists, press ESC .
ADAPTER SETUP UPDATED	206	Cadex BatteryShop has updated c-code in the battery adapter.	If message persists, press ESC .
BAD ADAPTER	210	The analyzer does not recognize adapter.	<p>Remove and re-insert the adapter.</p> <p>Delete and reenter the C-code.</p> <p>Clean the adapter contacts.</p> <p>Contact Cadex to upgrade firmware.</p> <p>If message persists, replace adapter.</p>

Detailed Message	CODE	Reasons	Solutions
BAD FUSE OR DRIVER	160	The analyzer is not able to supply current to the battery through its current drivers. Very low values of current (about 0 mA) are displayed on the analyzer and after 10 seconds processing stops.	<p>Clean the battery and adapter contacts.</p> <p>Verify that mAh rating of the battery matches the C-code.</p> <p>Lower the Charge rate and the Trickle Charge rate in the C-code.</p> <p>Use I/S settings (see <i>Intrinsically Safe Batteries</i>, page 57) if the battery is intrinsically safe.</p> <p>The battery may be faulty. Try a different battery in the same station.</p> <p>Single Cell NiCd or NiMH batteries may produce this error on the C7400ER. Service single cells on the C7200 or C7400.</p> <p>Check the fuses on the analyzer. If all fails, contact Cadex for service.</p>
BATSHOP MODE WAIT	34	Battery is detected on an analyzer connected to Cadex BatteryShop™. Waiting for user to start battery service in Cadex BatteryShop.	If service has been started and this message remains, verify the C-code in Cadex BatteryShop™ to ensure that settings are correct for the battery.
BATTERY INSERTED	20	The Cadex 7200 detects a battery in an adapter.	If message persists, press ESC.

Detailed Message	CODE	Reasons	Solutions
BATTERY OVER TEMP	14	Battery has overheated during charge. Station goes to Resting 00:00 (code 19) until the battery cools.	Reduce the Charge rate in the C-code. If using a non-OEM battery, the battery thermistor may be incorrect for the adapter. Contact Cadex to upgrade the adapter for your particular battery.
BATTERY OVERCHARGED	178	Current program completed; battery SoC (State of Charge) is too high.	Discharge the battery for 10 minutes and then charge again. Verify that correct contacts are used. Battery may have a high internal resistance. Verify with OhmTest and discard the battery.
HOT BATTERY ON TRICKLE CHARGE	159	Battery temperature has exceeded its maximum setting after service has ended and battery was on trickle charge. The trickle charge stops.	Verify that the mAh rating of the battery matches the C-code mAh setting. Reduce the Charge rate in the C-code. Reduce the trickle-charge rate or the maximum standby voltage in the extended C-code. Lower the room temperature.
BATTERY REMOVED	17	Battery was removed when the program completed.	This message appears briefly when the battery is removed. If message persists, press ESC .
BATTERY REMOVED	26	A five-second delay after the battery is removed when the program completed.	If message persists, press ESC .

Detailed Message	CODE	Reasons	Solutions
BATTERY REVERSED	121	Battery voltage too low (less than 0.30V/cell) on insertion.	<p>Battery may be connected backwards in the adapter. Ensure that battery leads are firmly connected to the battery.</p> <p>Apply a Boost.</p>
BATTERY SHORTED	122	Battery is not accepting charge in the initial charge cycle (the voltage remains low).	<p>Ensure battery leads are firmly connected to the battery.</p> <p>Battery may be fully discharged. Recharge battery in its original charger before placing it in the analyzer, or run Boost, (see Boost, page 36).</p> <p>Battery may have shorted cells - if unable to charge in the original charger, discard battery.</p>
BATTERY OVERCHARGED	176	<p>Battery SoC (State of Charge) is too high for QuickTest or OhmTest</p> <p>The battery is discharged for five minutes, after which QuickTest restarts. Discharge is repeated up to 5 times until SoC is below 90%.</p>	<p>If OhmTest is running, the program is aborted. Discharge the battery before running OhmTest again.</p> <p>Turn off the automatic OhmTest. If error continues, battery cannot be run on QuickTest or OhmTest.</p>

Detailed Message	CODE	Reasons	Solutions
BATTERY UNDERCHARGED	175	<p>Battery SoC (State of Charge) is too low for QuickTest or OhmTest</p> <p>The battery is charged for five minutes, after which QuickTest restarts. Charge is repeated up to 5 times until SoC is above 20%.</p>	<p>If OhmTest is running, the program is aborted. Partially charge the battery before running OhmTest again.</p>
BATTERY TOO COLD	12	<p>Battery temperature is too cold when inserted. The battery is trickle charged until temperature rises above 5°C</p>	<p>Allow the battery to warm up.</p> <p>If the battery is non-OEM, the thermistor may not match that on the adapter.</p>
BATTERY TOO HOT	13	<p>Battery temperature is too hot when inserted. The battery automatically starts processing when temperature drops 5°C below maximum value set in the C-code Temperature Sensing.</p>	<p>Allow the battery to cool or use the analyzer in a cooler room.</p> <p>If the battery is non-OEM, the thermistor may not match that on the adapter.</p>
BATTERY UNDERCHARGED	177	<p>Current program completed; battery SoC (State of Charge) low.</p>	<p>Run the Charge program on the battery.</p>
CALIBRATION FAULT	170	<p>Current cannot pass through shorted terminal during calibration.</p>	<p>A minimum AWG 10 (2.5 mm) wire is recommended to short contacts/leads.</p> <p>The wires may have disconnected during the calibration process.</p> <p>Repeat calibration procedure.</p>

Detailed Message	CODE	Reasons	Solutions
CAP. IMPROVED TO TARGET	195	Target capacity is achieved or exceeded after an initial warning	See code 115, Target capacity not met.
C-CODE NOT USABLE	214	C-code is not suitable or is out of range for the analyzer.	<p>The C-code may have been created on an “Extended Range” (ER) analyzer or an analyzer with more recent firmware version.</p> <p>Verify required battery parameters and edit or re-enter the C-code.</p> <p>Update the firmware on your analyzer to the most recent version if necessary (see Upgrading the Firmware, page 120).</p>
CELL MISMATCH	112	For NiCd or NiMH batteries only. Cells are reaching full charge at different times so the negative slope is not well defined. The program proceeds to the next cycle.	<p>Wait until processing is complete because the Auto and Prime programs will attempt to correct this warning through several more charge and discharge cycles. If corrected, code 192 (Cell mismatch corrected) appears.</p> <p>Reduce the negative slope in extended C-code to 8mV/cell.</p> <p>Battery is old or has been in storage. Operating time may be reduced. Either monitor battery use or discard the battery.</p> <p>If the battery is new, use the Prime program.</p>

Detailed Message	CODE	Reasons	Solutions
CELL MISMATCH CORRECTED	192	Cell mismatch (code 112) is corrected through several charge/discharge cycles.	Use the battery as normal.
HOT BATTERY/HEAT TERMINATION	158	Midway during charge the temperature went above the maximum set in the C-code. Program resumed when battery cooled by 5°C. A WAIT code may appear for the battery to cool before the next process begins.	See code 154, Charge complete temp rise. Reduce charge rate if problem persists (see page 47).
CHARGE CURRENT LOW	164	Current driver cannot provide the requested charge current	See code 160, Bad fuses or driver.
CHARGE CYCLE COMPLETE	30	Charge cycle completed.	Program is going to the next step.
CHARGE TIMEOUT	144	Charge time has exceeded the expected value for the battery.	Verify that the mAh rating of the battery matches the C-code mAh setting. Analyzer may not have detected the end of charge conditions. Reduce the negative slope to 8mV/cell for NiCd and NiMH. Raise the End of Charge settings for Li-ion or SLA.
CHARGE WAIT	9	Station is on hold until sufficient power is available.	This is normal if large batteries are being serviced. Service resumes automatically when sufficient power is available to the station.
CHARGING	2	Battery is being charged normally.	

Detailed Message	CODE	Reasons	Solutions
RAPID HEAT RISE	154	Midway during charge the temperature rose too rapidly (more than 2°C in 2 minutes). Program stops until battery is cooled by 5°C and then resumes. A WAIT code may appear for the battery to cool before the next process begins.	Wait until processing is complete. Lower the charge rate in the extended C-code. Observe battery performance. The battery may be old.
CURRENT RISE AT FULL CHARGE	130	Generally for SLA and Li only. Battery current suddenly increased as the end-of-charge condition was achieved.	Raise the End of Charge settings. If the SLA battery is a Hawker cell, use the Hawker C-code settings (see page 58). Allow the station to complete service.
CYCLE RESUMED	32	Power resumed or the battery is re-inserted into the adapter.	
DCHG CYCLE COMPLETE	31	Discharge cycle completed.	Program is going to the next step.
DISCHARGE CURRENT LOW	162	The analyzer cannot discharge the battery. Very low values of current (< 50mA) are displayed on the analyzer before this code appears	(See code 160, Bad fuses or driver).
DISCHARGE TIMEOUT	142	Battery capacity has exceeded 250% of the rated capacity.	Verify that the mAh rating of the battery matches the C-code mAh setting. Raise the discharge rate in the extended C-code.
DISCHARGE WAIT	6	Station is on hold until sufficient power is available.	Wait until other stations have completed battery service.

Detailed Message	CODE	Reasons	Solutions
DISCHARGING	7	Battery is being discharged normally.	Program will continue when cycle has completed.
HIGH CELL RESISTANCE	135	Battery resistance has exceeded the OhmTest setpoint threshold	Program is complete (see <i>To edit the OhmTest Setpoint</i> , page 34).
HIGH CELL RESISTANCE	136	The battery resistance has exceeded the OhmTest setpoint threshold – this message is for BatteryShop™	Program is complete (see <i>To edit the OhmTest Setpoint</i> , page 34).
HOT BATTERY, LOW VOLTAGE	156	Battery temperature went to its maximum setting in the initial charge cycle. Service terminates.	Reduce the Charge rate in the C-code. Allow battery to cool before servicing the battery again. The internal cells may have shorted or the battery is old. Either monitor battery use or discard.
INSERT THE BATTERY	8	Insert battery in the battery adapter.	

Detailed Message	CODE	Reasons	Solutions
INTERMITTENT BATTERY	129	Battery connection opened five times in one minute.	<p>Check and clean the battery contacts. Verify that correct contacts are used. Verify that the battery is properly inserted. Verify that the C-code is correct for the battery.</p> <p>Reduce the charge rate in extended C-code. Increase end-of-discharge voltage.</p> <p>For intrinsically safe batteries, use I/S settings (see <i>Intrinsically Safe Batteries</i>, page 57).</p>
INTERNAL ERROR	(NONE)	Display Buffer is full	<p>Machine will reset in a few minutes a resume service. If message persists, press the Esc key for a few minutes, the machine will reboot and resume service.</p> <p>This may occur if QuickTest™ (a processing intensive program) is used. Start QuickTest™ in each station after 10 seconds.</p>

Detailed Message	CODE	Reasons	Solutions
INVALID PASSWORD ENTERED	204	(Code 204) An incorrect password has been entered.	<p>Enter the correct password.</p> <p>If message persists or if no password should be required, replace backup battery (see <i>Replacing the Backup Battery</i>, page 115).</p> <p>If correct password is unknown, contact Cadex with unit serial number.</p>
LOW VOLTAGE AT NEG. SLOPE	126	A negative slope was detected when the battery voltage was low. I.e. The battery acted as if it was fully charged even though it was empty.	<p>Reduce the charge rate in the Extended C-code. If battery is a high capacity NiCd, reduce the charge rate to 0.5C.</p> <p>Prime the battery.</p> <p>The battery's high impedance may be causing this failure so use the Intrinsically Safe C-code.</p> <p>If all fails, discard the battery.</p>
RAPID HEAT RISE	152	On initial charge, the battery temperature is rising too rapidly (2°C in 1 minute) For safety, charging is terminated.	<p>Use ExtPrime program if the battery has been in storage</p> <p>Reduce the charge rate in the extended C-code.</p> <p>The battery may be old or have shorted cells. Discard the battery.</p>
LOW VOLTAGE (TIMEOUT 1)	123	Battery voltage remains low (less than 0.80V/cell) after approximately one minute into the charge cycle	See code 122, Battery shorted.

Detailed Message	CODE	Reasons	Solutions
LOW VOLTAGE (TIMEOUT 2)	124	Battery voltage remains low (less than 0.80V/cell) after approximately ten minutes into the charge cycle	See code 122, Battery shorted.
LOW VOLTAGE (TIMEOUT 3)	127	Charge terminated. Correct voltage could not be obtained in allotted time due to high battery capacity for set charge current, incorrect voltage setting, or shorted cells.	Verify C-code settings and battery rating. Replace battery if low voltage remains.
N/A mΩ	(No code)	OhmTest has not been performed, so no resistance reading is available.	Battery readings are above the readable values for the analyzer.
NO ADAPTER	1	No battery adapter is inserted, or the inserted adapter is not detected.	Check contacts. Clean with a lint-free cotton swab dipped in 100% isopropyl alcohol.
NO BATTERY	10	No battery is inserted, or the inserted battery is not detected.	Check contacts. Turn on battery switch if applicable. Check for correct battery for the adapter and adapter contacts. Clean all contacts. Run Boost, (see Boost , page 36).
NO NEGATIVE SLOPE ON TIMEOUT 1	125	A plateau was detected when the battery voltage was low. I.e. The battery acted as if it was fully charged even though it isn't.	Increase the charge rate in the C-code. If the battery was in storage, use Ext. Prime. If all fails, discard the battery.
NULL C-CODE IN ADAPTER	211	An empty C-code is selected.	Select a programmed C-code or program the selected empty C-code.

Detailed Message	CODE	Reasons	Solutions
OVER VOLTAGE	120	Battery voltage is too high.	<p>Verify the C-code voltage setting, (see Battery Voltage (Volts), page 45).</p> <p>If the battery is new, charge it for a few minutes in the original charger.</p> <p>Li-ion safety circuits may be activated. Discharge the battery in its original equipment for a few minutes. For SLA batteries, check the electrolyte.</p> <p>If all fails, discard the battery.</p>
PASSWORD ENTERED	203	System password has been entered and activated.	Password is required for some actions, depending on security level selected, (see Security , page 75).
PLATEAU TIMEOUT	113	Battery was fully charged before full-charge conditions were met. For SLA and Li batteries only.	The end-of-charge setting in the C-code may have to be increased. Battery may be old and operating time less than manufacturer's specifications.
POWER ON	200	Power is detected inside the analyzer.	
PROCESS COMPLETE	15, 35, 36	Current battery-service program is complete.	
PROCESS SUSPENDED	18	Battery is removed during service.	Re-insert battery within 5 seconds to resume service. If message persists, see Code 188 for further information.

Detailed Message	CODE	Reasons	Solutions
SERVICE INTERRUPTED	188	Battery is removed during service for more than five seconds. Program terminated.	<p>If the battery was not removed the battery protection circuit or thermistor may have activated disconnecting the terminals. The analyzer then thinks that the battery has been removed.</p> <p>If the battery is hot, reduce heating by lowering the Charge and Discharge. For Li-ion batteries, reduce the Max Charge voltage or the Max Standby Voltage.</p>
PROCESS RESUMING	25	(Code 25) Battery service is continuing after a power interruption.	This message appears after the initial startup screen and remains until the analyzer determines the point at which battery service was interrupted and resumes the current program from that point.
CUSTOM PROGRAM HAS FAILED – DISPLAY WILL SHOW REASON FOR FAILURE	16	(Code 16) The custom program has produced an error. The Next statement is not processed. The program has been terminated.	<p>See the detailed display for the exact nature of battery failure.</p> <p>If Code 16 is displayed, then there is a bug in the custom program - verify the custom program statements.</p>
READY	5	Service has completed and battery is ready. Final capacity or state of health is displayed.	Faults or warnings (if any) were corrected. Remove battery and use as normal.

Detailed Message	CODE	Reasons	Solutions
RECONDITION TIMEOUT	146	Recondition time has exceeded the expected value for the battery. Program goes to the next cycle.	<p>Verify the mAh settings on the C-code.</p> <p>Raise the recondition discharge rate, (see Recondition Discharge Rate, page 49).</p> <p>The battery may be intrinsically safe, preventing deep discharge. Use I/S settings for the battery, (see Intrinsically Safe Batteries, page 57)</p> <p>If battery is new or has been in storage, use the Prime program.</p> <p>Cells may be mismatched, run the Prime program.</p> <p>Monitor the battery use.</p>
RECONDITIONING	4	Battery is being reconditioned.	The program will proceed to the next step when recondition has completed.
RESISTANCE TEST	27	A manually selected or programmed resistance test for the battery is in progress.	Program completes in 5 seconds.
RESISTANCE TEST	28	An automatic resistance test in a factory program (Prime, QuickTest™ or Auto) is in progress.	Program completes in 5 seconds and will continue to the next step of the program.
RESTING	19	Station is in a rest period, as specified in the custom program.	The program will proceed to the next step when resting period is complete.

Detailed Message	CODE	Reasons	Solutions
RESTING	21	Station is in an automatic rest period specified in the charge program for NiMH batteries when temperature sensing in the C-code is not enabled.	This message appears for NiMH batteries only. The program will proceed to the next step when resting is complete.
SECURITY ENABLED	205	System security has been activated.	Password required for some actions, depending on security level selected.
SETTING UP CALIBRATION	22	Station is preparing for a calibration process.	If message persists, remove the adapter. Turn off the analyzer.
SMART ADAPTER FAULT	171	The analyzer has old firmware incompatible with the adapter.	Contact Cadex to obtain a firmware upgrade.
SMART BATTERY FAULT	172	The analyzer has old firmware incompatible with the adapter.	Contact Cadex to obtain a firmware upgrade.
UNABLE TO CLAMP CHARGE VOLTAGE	128	Battery voltage is too high: NiCd and NiMH - more than 1.8V/cell SLA – more than 2.75V/cell. Li-ion – more than 4.5V/cell Processing has ended.	Battery may be a high capacity type battery. Reduce the charge rate. Battery may be overcharged. Discharge the battery for 10 minutes, then charge again. Battery is new. Use the Prime program to prepare the battery for use. Raise End of Charge (SLA and Li-ion) to 0.10C. Check that correct contacts are used.

Detailed Message	CODE	Reasons	Solutions
CHARGE CURRENT REDUCED	118	Battery voltage exceeds maximum limit (1.8V/cell for NiMH and NiMH, 2.75V/cell for SLA). Analyzer will attempt to complete service by reducing current rate to half.	<p>Wait until processing is complete. If voltage rises again, code 128 (Soft battery) appears and the program ends.</p> <p>Reduce the charge rate in the extended C-code.</p> <p>If the battery is new or has been in storage, use the Prime program.</p>
START BATTERY PROCESS	11	Battery service has started.	If message persists, press Esc.
STATION CALIBRATING	23, 29	Station is being calibrated.	This process takes 10 – 20 seconds, wait until it completes
STATION OFF LINE	0	Station is not reading the adapter.	<p>Remove the adapter and restart the analyzer.</p> <p>Make sure all your analyzers have the same firmware version number. Delete the C-code that was selected for the battery.</p> <p>Reset the system, (see Resetting the System, page 120).</p>
SYSTEM TEMP. HIGH: COOLING	207	Service on all stations are temporarily suspended due to high temperature inside the analyzer.	<p>Service will resume in a few minutes, after the board has cooled down. If it reoccurs continually, move the analyzer to a cooler room.</p> <p>The firmware chip in the analyzer may be loose. Contact Cadex for instructions to reinsert firmware.</p>

Detailed Message	CODE	Reasons	Solutions
TARGET CAPACITY NOT MET	115	Battery capacity is below the target capacity. The analyzer attempts to improve the capacity by reconditioning the battery.	Wait until service is complete. The Auto and Prime programs will try to correct this warning. If corrected, Code 195 appears. If not corrected, Code 116 appears. See Code 195 and 116 for further information.
TARGET CAPACITY NOT MET	116	Final capacity of the battery is below the target capacity. Attempts to improve battery capacity did not succeed in bringing capacity above target.	Confirm that the battery rating matches the C-code mAh setting. Battery is old and has less operating time than manufacturer's specification.
THERMISTOR FAILURE	150	The battery temperature reading is invalid.	Clean the contacts on the battery. Thermistors on non-OEM batteries may not be the same as that used on OEM batteries. Contact Cadex to upgrade the adapter for your particular battery. If the battery is NiCd or NiMH, turn off the temperature sensing. If the battery is known to be good or the adapter has two contacts (in these adapters, the negative contact is a thermistor), the battery thermistor is defective, contact Cadex.

Detailed Message	CODE	Reasons	Solutions
TRICKLE CHARGE	3	The program is running a trickle charge. The reconditioning process is complete, and the battery is being recharged.	
UNABLE TO LEARN MATRIX	179	A matrix cannot be created because: battery capacity is less than 50%, the OhmTest reading does not produce a result or the battery cannot handle 1.00C charge or discharge rate required by Learn	Use another battery to run Q-Learn or Learn.
USER PROGRAMMED TIMEOUT	33	The time programmed in a custom program has completed.	The program goes to the next step.

Appendix B

Charge Algorithms

The C7000 series battery analyzer uses two different algorithms to charge a battery: a constant current (CC) method for NiCd and NiMH batteries and a constant current/constant voltage (CC/CV) method for Li-ion and SLA batteries.

NiCd and NiMH batteries

The C7x00 analyzer uses a Constant Current algorithm to charge NiCd and NiMH batteries. A current and voltage plot is shown for a typical NiCd battery serviced on the analyzer using default values. This plot is similar to a NiMH battery.

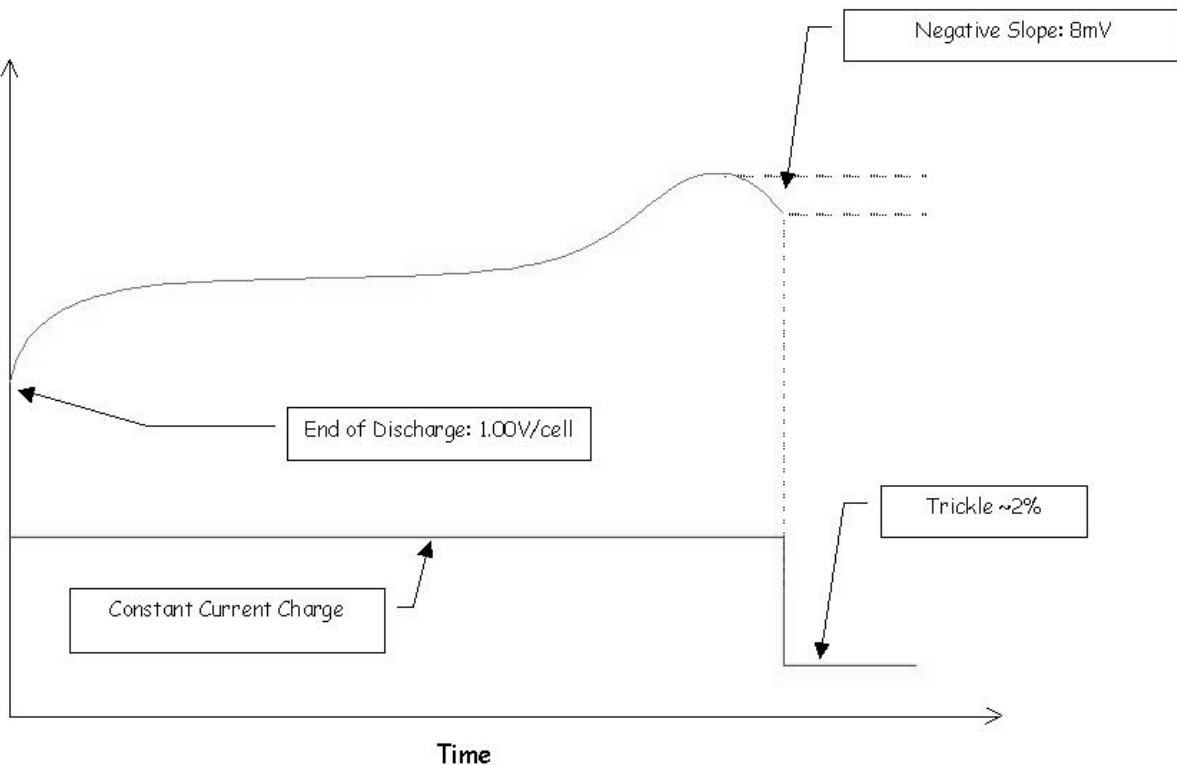

A battery that is fully discharged is about 1.00V/cell. During charge, the analyzer applies a constant current. As the battery gets charged, the voltage rises. Charge is terminated depending on how the NiCd and NiMH Optimization have been set (see **Setting the Optimization**, page 81).

If NiCd and NiMH Optimization have been set to Capacity, the battery is terminated when a negative slope (a gradual voltage drop indicating that the battery is fully charged) is encountered. If there is a voltage plateau or temperature rise more than dT/dt , the current is reduced by half and the charge continues till the battery reaches full charge. For NiMH batteries, the current is often reduced by half twice.

If NiCd and NiMH Optimization have been set to Time (this is the default setting), the temperature will be monitored and charge will terminate when the battery reaches either the negative slope, dT/dt or maximum battery temperature.

This table summarizes the charge methods:

NiCd and NiMH Optimization	dT/dt	Negative Slope (dV/dt)	Max Temperature
Capacity	Current is reduced	Charge is complete	Current is reduced
Time	Charge is completed	Charge is completed	Charge is completed

SLA and Li-ion batteries

The C7x00 analyzer uses a Constant Current/Constant Voltage Charge algorithm to charge SLA and Li-ion batteries. A current and voltage plot is shown for a typical Li-ion battery serviced on the analyzer with default C-Code settings. This plot is similar for the SLA battery.

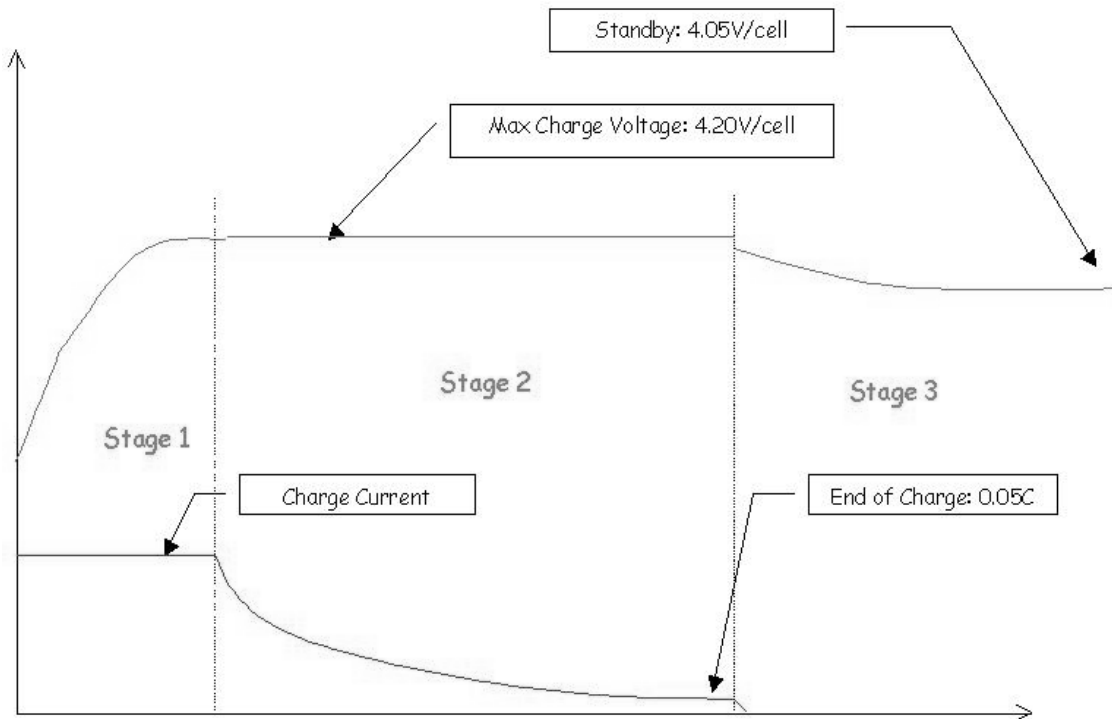

There are three stages during the charge:

Stage 1: the battery is charged at a constant current (this current is the 'Charge Rate' in the Extended C-Code) until the battery reaches the Maximum Charge Voltage (set in the Extended C-Code) is reached.

Stage 2: When the battery reaches Maximum Battery Voltage, the analyzer switches to constant voltage. During this stage, current is reduced to maintain Maximum Charge Voltage until the End of Charge current (set in the C-Code) is reached.

If SLA and Li Optimization are set to Capacity (**see *Saving Program and Target Capacity Settings***, page 80), the charge time is extended for approximately 20 minutes after End of Charge has been reached. This additional charging period may add 4% to 6% capacity; however, you may find that the increase in capacity is not worth the additional time.

If SLA and Li Optimization are been set to Time (this is the recommended setting), charge will terminate as soon as End of Charge has been reached.

In both cases of Optimization settings, exceeding dT/dt will fail a battery.

Stage 3: After the charge has completed, the battery is maintained at a constant voltage level (this is voltage is the Maximum Standby Voltage set in the C-Code).

This table summarizes the charge methods:

SLA and Li Optimization	dT/dt	End of Charge	Max Temperature
Capacity	Fail 152 or Fail 158	Approximately extra ~20 minutes charge time added	Charge continues after temperature drops 5°C below max threshold
Time	Fail 152 or Fail 158	Charge completes as soon as end of Charge is reached.	Charge continues after temperature drops 5°C below max threshold

Appendix C

Specifications

Hardware

Battery Analyzers	C7200	C7400	C7400ER
Part Numbers	07-720-0000	07-740-0000	07-740-1000
Independent stations	2	4	4
Battery voltage	1.2-15V	1.2-15V	Li-ion and SLA 1.2-36V NiCd and NiMH: 1.2 – 28.8V
Charge/discharge current	100mA-4A	100mA-4A	100mA-4A*
Accuracy	+/- 1% at max rated voltage, +/- 2% at 4000mA Services batteries up to 24Ah. If set above 4A*, the current automatically scales down.		
Maximum charge power	40W per station; 40W total	55W per station; 80W total	75W per station; 170W total
Maximum discharge power	35W per station; 70W total	35W per station; 140W total	50W per station; 200W total
Power management	On high load demands, the current scales down; large batteries may go on waiting queue		
Line voltages	100-240VAC, 50- 60Hz; 1.5A max	100-240VAC, 50- 60Hz, 1.75A max	100-120/200-240VAC, 50- 60Hz; 4A max
Chemistries	Lithium-ion, nickel-metal-hydride, nickel-cadmium; lead-acid		
Charge method	Automatic full charge detection, safe termination under all conditions. Temperature controlled. Lithium-ion and lead-acid: constant voltage with current limit. Nickel-based: constant current with Reverse Load adjustable from 5-12%. Customized charge methods possible.		

Discharge method	Constant discharge current to end-of-discharge voltage threshold																		
Battery Adapters	Custom and universal SnapLock™ adapters. Each adapter holds up to 10 C-codes to service different battery types. Re-programmable with menu function. Temperature controlled.																		
Security	<p>Level 0 Open, no programming restrictions (default)</p> <p>Level 1 Password protected (low); allows C-code selection and display options</p> <p>Level 2 Password protected (high); most programming choices are locked</p>																		
Display	80-character LCD, backlit; each station also features RUN, READY, FAIL signal lights																		
Data Ports	RS-232 interfaces to PC and label printer, parallel printer port and USB (future release) on C7400 and C7400ER only. BatteryShop™ supports special printers.																		
Throughput	<p>QuickTest™ 30-40 batteries/hr 60-80 batteries/hr</p> <p>Full service Fleet of 80 batteries typical Fleet of 160 batteries typical</p> <p>Throughput on full service is based on recommended monthly maintenance. Each analyzer services two battery batches every 24h (day and night run), 20 days per month.</p>																		
Physical	<table border="1"> <tr> <td>Length</td> <td>12.1"; 312mm</td> <td>14.4"; 360mm</td> <td>15.4"; 398mm</td> </tr> <tr> <td>Width</td> <td>9.4"; 240mm</td> <td>11.0"; 280mm</td> <td>11.0"; 280mm</td> </tr> <tr> <td>Height</td> <td>3.5"; 90mm</td> <td>3.8"; 100mm</td> <td>4.2"; 107mm</td> </tr> <tr> <td>Weight</td> <td>7.1lb.; 3.2 kg</td> <td>10.05lb.; 4.54kg</td> <td>12.1lb; 5.5kg</td> </tr> </table>			Length	12.1"; 312mm	14.4"; 360mm	15.4"; 398mm	Width	9.4"; 240mm	11.0"; 280mm	11.0"; 280mm	Height	3.5"; 90mm	3.8"; 100mm	4.2"; 107mm	Weight	7.1lb.; 3.2 kg	10.05lb.; 4.54kg	12.1lb; 5.5kg
Length	12.1"; 312mm	14.4"; 360mm	15.4"; 398mm																
Width	9.4"; 240mm	11.0"; 280mm	11.0"; 280mm																
Height	3.5"; 90mm	3.8"; 100mm	4.2"; 107mm																
Weight	7.1lb.; 3.2 kg	10.05lb.; 4.54kg	12.1lb; 5.5kg																
Environmental	<p>Operating temperature 41°F to 95 °F; 5°C to 35°C</p> <p>Storage temperatures –40°F to 167°F; -40°F to 75°C</p>																		
Firmware	Upgradeable with BatteryShop™, flash memory. Lifetime upgrade subscription available.																		
Approvals	Tested and approved by ITS and TUV to comply with CSA/UL/CE/PSE standards. (PSE not available on C7400ER)																		
Warranty	Cadex warrants the analyzer against defective materials and workmanship for a period of three (3) years from the original purchase date.																		

* A 6A charge/discharge current can be used with specialized / customer adapters.

Appendix D

Parts and Accessories

Part	Cadex Part Number (P/N)
Cadex Battery adapters	Visit www.cadex.com for the latest list of battery adapters available.
Smart Cable (universal battery adapter)	07-110-0115
DYMO SE300 Label printer	00-004-3013
DYMO Battery labels, 1500/roll	00-004-3031
Battery labels for dot-matrix printers (Epson FX-850-compatible) 1.625" x 0.438", 5000/pack	88-110-0010
SP-2 serial/parallel converter cable	04-880-0031
Voltage-calibration kit (with instructions and calibration adapters)	92-770-0210
Power cord, 6'	68-723-1804
Cadex User's manual	89-307-1013
C7200 & C7400 Primary Fuse T2.0A 250 V	52-546-0200
C7400ER Primary Fuse T5.0A 250V	52-546-0500
Lithium coin cell backup battery	45-206-0001
Cadex BatteryShop (battery-management software for Windows)	Contact Cadex Electronics Inc. or your authorized Cadex dealer for more information about Cadex software products.
Book: <i>Batteries in a Portable World</i> , 2 nd edition	Contact Cadex Electronics Inc. or visit our Web site (www.cadex.com).

Index

- adapters, battery, 14, 162
 - 16 kilobit, 25, 38, 40, 129
 - calibrating, 123
 - copying, 63
 - inserting, 15, 17
 - removing, 16
 - setup report, 85
 - Smart Cable, 15, 43, 47, 124
- adapters, custom. *See* adapters, battery
- adapters, voltage calibration
 - servicing, 123
- advanced programs. *See also* programs
 - Boost, 28, 36
 - custom, 28, 41
 - Discharge Only, 27, 31
 - editing, 29, 34, 35
 - Extended Prime, 27, 32
 - Learn, 28, 38, 40
 - Life Cycle Test, 27, 30
 - OhmTest, 27, 33
 - RunTime, 28, 34
 - Self-Discharge Test, 27, 29
- Auto program, 22, 23
- automatic OhmTest, 79, 140, 141
- Auto-Print, 88
- backup battery, 162
 - replacing, 115, 119
- bar code labels, 87
- basic programs, 22. *See also* programs
 - Auto, 22, 23
 - Charge, 22, 24
 - Prime, 23, 25
 - Quicktest, 23, 25
- batteries
 - basic service, 17
 - displaying number serviced, 70
 - Gell SLA, 58
 - Hawker SLA, 47, 58, 144
 - inserting, 16, 18
 - intrinsically safe, 47, 57, 128, 151
 - removing, 16
 - service programs, 22
 - service time, 42
 - servicing, 17
 - smart, 6, 32, 52
 - voltage, 45
- Batteries in a Portable World*, 130, 162
- battery adapters, 14, 162
 - 16 kilobit, 25, 38, 40, 129
 - calibrating, 123
 - copying, 63
 - inserting, 15, 17

- removing, 16
- setup report, 85
- Smart Cable, 15, 43, 47, 124
- battery capacity, 46
- battery chemistries, 45
- battery configuration, 43
- battery labels, 86, 162
- battery rating, 46
- battery service counter, 69
 - disabling, 69
 - restarting, 69
 - setting, 69
- battery service report, 85, 87
- battery startup setting, 78
- battery, backup, 162
 - replacing, 115, 119
- Boost. See Boost program
- Boost program, 28, 36, 140, 148
 - editing, 37
 - running, 36
- Buchmann, Isidor, 130
- Cadex Batteryshop, 41, 85, 120, 137, 138, 162
 - connecting to, 72
- Cadex Firmware Utility, 120
- calibrating
 - battery adapters, 123
 - stations, 123
 - voltage, 122
- calibration, 122
- calibration adapters
 - servicing, 123
- calibration kit, 162
- capacity
 - battery, 46
 - offset, 49

- target, 6, 45, 81, 111, 142, 154
- C-Code parameters, basic, 44
 - battery capacity, 46
 - battery rating, 46
 - battery voltage, 45
 - chemistry, 45
 - mAh, 46
 - program, 44
 - target capacity, 45
 - type, 45
 - volts, 45
- C-Code parameters, extended, 47
 - capacity offset, 49
 - charge rate, 47
 - C-Rate, 47
 - discharge rate, 48
 - end of charge, 54
 - end of discharge, 51
 - negative slope, 51
 - recondition discharge rate, 49
 - temperature sensing, 50
 - trickle-charge rate, 49
- C-Codes, 15, 43
 - copying, 63
 - creating, 59
 - deleting, 62
 - displaying, 19, 59
 - editing, 59, 61
 - managing, 58
 - naming, 46
 - resetting extended parameters, 62
 - selecting, 19, 58
 - setting active, 58
 - setup name, 46
- changing
 - password, 77

- target capacity, 59
- charge
 - end of, 54
 - optimizing, 80
 - rate, 47
 - trickle, 6, 49
- Charge program, 22, 24
- chemistry, battery, 45
- cleaning analyzer, 121
- clearing event log, 94
- components, 8, 9
- computer, connecting to, 70, 72
- confidence grade, 26, 97
- configurations, serial cable pin, 73, 74
- connecting
 - to Cadex Batteryshop, 72
 - to computer, 70, 72
 - to label printer, 70, 72, 74
 - to printer, 70, 74
- copying
 - battery adapters, 63
 - C-Codes, 63
 - Quicktest matrices, 63
- counter, battery service. See battery service counter
- C-Rate (C), 47
- creating
 - C-Codes, 59
 - custom programs, 109
- custom adapters. See battery adapters
- custom programs, 28, 41, 104
 - creating, 109
 - editing, 109
 - phases, 105, 107, 109
- cycle 1, 105
- cycle 2, 105
- data log, 95
 - setting up, 99
- default settings
 - extended C-Codes, 57, 58
- deleting
 - C-Codes, 62
- detailed display, 11
- devices
 - output, 70, 74
- discharge
 - end of, 51
 - rate, 48
 - recondition, 49
 - self, 6
- Discharge Only program, 27, 31
 - editing, 32
- display, 132
 - detailed, 11
 - global, 10
 - lights (LEDs), 12
- displaying
 - C-Codes, 19, 59
 - event log, 94
 - firmware version, 120
 - number of batteries serviced, 70
- done phase, 109
- editing
 - Boost program, 37
 - C-Codes, 59, 61
 - custom programs, 109
 - Discharge Only program, 32
 - Life Cycle Test program, 31
 - OhmTest program, 34
 - RunTime program, 35
 - Self-Discharge Test program, 29
 - target capacity, 59

- ELSE statements, 108
- end of charge, 54
- end of discharge, 51
- event log, 92
 - clearing, 94
 - displaying, 94
 - events, 92
 - printing, 94
- extended C-Codes
 - default settings, 57, 58
- Extended Prime program, 27, 32
- FALSE statements, 108
- firmware
 - displaying version, 120
 - upgrading, 120
- function (Fn) keys, 8, 62, 63, 64, 70, 120, 123
- fuse
 - primary (input), 162
 - replacing, 114
- Gell SLA batteries, 58
- global display, 10
- Hawker SLA batteries, 47, 58, 144
- IF statements, 107
- input fuse, 162
 - replacing, 114
- inserting
 - batteries, 16, 18
 - battery adapters, 15, 17
- internal resistance. *See* resistance
- intrinsically safe batteries, 47, 57, 128, 151
- keys, 8, 9
 - function (Fn), 8, 62, 63, 64, 70, 120, 123
- label printer, 71

- connecting to, 70, 72, 74
- labels
 - bar code, 87
 - battery, 86, 162
 - printing, 89
- Learn program, 28, 38, 40
- LEDs, 12
- Life Cycle Test program, 27, 30, 120
 - editing, 31
- lights (LEDs), 12
- log
 - data. *See* data log
 - event. *See* event log
- managing
 - C-Codes, 58
- matrix, Quicktest, 58
 - copying, 63
- menu, 13
- messages, 96, 132
- modifying. *See also* editing
- name, C-Code, 46
- negative slope, 51
- NULL code, 18, 136
- offset, capacity, 49
- OhmTest program, 27, 33, 120, 123, 140, 141
 - editing, 34
- OhmTest, automatic, 79, 140, 141
- optimizing charge, 80
- output devices, 70, 74
- parallel port settings, 74
- parameters, basic C-Code. *See* C-Code parameters, basic
- parameters, extended C-Code. *See* C-Code parameters, extended
- parts, 8, 9

- passwords
 - changing, 77
 - required at security levels, 75
- phases, custom programs
 - cycle 1, 105
 - cycle 2, 105
 - done, 109
 - test, 107
- primary (input) fuse, 162
 - replacing, 114
- Prime program, 23, 25, 151
- printer, 74
 - connecting to, 70, 74
 - label, 71
- printing
 - event log, 94
 - reports and labels, 89
- programs, 44
 - Auto, 22, 23
 - basic, 22
 - battery service, 22
 - Boost, 28, 36, 140, 148
 - Charge, 22, 24
 - custom, 28, 41, 104
 - creating, 109
 - editing, 109
 - phases, 105, 107, 109
 - Discharge Only, 27, 31
 - editing specialty, 29, 34, 35
 - Extended Prime, 27, 32
 - Learn, 28, 38, 40
 - Life Cycle Test, 27, 30, 120
 - OhmTest, 27, 33, 120, 123, 140, 141
 - Prime, 23, 25, 151
 - Quicktest, 23, 25, 97, 123, 140, 141
 - RunTime, 28, 34, 120
 - Self-Discharge Test, 27, 29, 120
 - service time, 42
- QuickLearn, 38, 40
- Quicktest matrices, 58
 - copying, 63
- Quicktest program, 23, 25, 97, 123, 140, 141
- rate
 - charge, 47
 - discharge, 48
 - recondition discharge, 49
 - trickle charge, 49
- rating, battery, 46
- rebooting system, 120
- recondition discharge rate, 49
- removing
 - batteries, 16
 - battery adapters, 16
 - security, 76
- replacing
 - backup battery, 115, 119
 - primary (input) fuse, 114
- reports
 - adapter setup, 85
 - battery service, 85, 87
 - printing, 89
 - system setup, 85
- resetting extended C-Code parameters, 62
- resetting system, 120
- resistance
 - defined, 6
- running
 - Boost program, 36
- RunTime program, 28, 34, 120
 - editing, 35

- safety
 - precautions, 36
- security, 75
 - levels, 75
 - passwords, 75
 - removing, 76
 - setting level, 76
- selecting
 - automatic OhmTest, 79
 - C-Codes, 19, 58
 - charge optimization, 80
 - correct voltage, 45
- self-discharge, 6
- Self-Discharge Test program, 27, 29, 120
 - editing, 29
- serial cable pin configurations, 73, 74
- serial device settings, 72
- serial port settings, 71, 100
- serial/parallel converter, SP-2, 162
- service counter. *See* battery service counter
- services. *See also* programs
- servicing
 - batteries, 17
 - voltage calibration adapters, 123
- setting
 - active C-Code, 58
 - password, 77
 - security level, 76
 - sound control, 66
- settings
 - default extended C-Codes, 57, 58
 - parallel port, 74
 - serial device, 72
 - serial port, 71, 100
 - system. *See* system settings
- setup name, C-Code, 46
- slope, negative, 51
- smart batteries, 6, 32, 52
- Smart Cable Adapters, 14, 15, 43, 47, 124
- SOC. *See* State of Charge
- SOH. *See* State of Health
- sounds, 66, 67
- SP-2 serial/parallel converter, 162
- specialty programs. *See* advanced programs
- State of Charge, 6, 26, 139, 140, 141
- State of Health, 6, 26, 97
- statements
 - ELSE, 108
 - FALSE, 108
 - IF, 107
 - THEN, 108
 - TRUE, 108
- stations, calibrating, 123
- system
 - rebooting, 120
 - resetting, 120
- system security. *See* security
- system settings, 65
 - automatic OhmTest, 79
 - battery startup, 78
 - calibration, 122
 - charge optimization, 80
 - sounds, 66, 67
 - voltage, 68
- system setup report, 85
- target capacity, 6, 45, 81, 111, 142, 154
 - changing, 59
- technical support, 131

- temperature sensing, 50
- terminal, 99
- test in custom program, 107
- tests
 - automatic OhmTest, 79, 140, 141
 - Life Cycle, 27, 30, 120
 - OhmTest, 27, 33, 120, 123, 140, 141
 - Quicktest, 23, 25, 123, 140, 141
 - RunTime, 28, 34
 - Self-Discharge, 27, 29, 120
- THEN statements, 108
- trickle charge, 6
 - rate, 49
- troubleshooting, 126
- TRUE statements, 108
- upgrading firmware, 120
- user interface, 10
- version, firmware, 120
- viewing. See displaying
- voltage
 - battery, 45
 - calibrating, 122
 - calibration adapters
 - servicing, 123
 - calibration kit, 162
 - display setting, 68
 - selecting correct, 45
- warnings, 96, 132